

The complete product range

# Product catalogue 2019





# “This is where they are made: simply great knives.”

Professional knives ‘made in Germany’ are durable and reliable, day after day. That is what GIESSER represents. A genuinely good knife is more than a blade with a handle. Each and every one of our products represents the culmination of six generations of expertise in the art of knife-making. Now, as then, we work with a passion for precision, meticulously hand-pick our materials and never stop honing the quality of our knives. Our outstanding industrial manufacturing standards involve manual controls of every single knife. And we are especially proud to be extending the same care to the way in which we interact with our staff: strong, lasting employment relationships are at the heart of our company philosophy. As a provider of apprenticeships, we invest in the future, and our efforts pay off: our apprentices are regularly lauded as the best junior cutting-tool mechanics in Germany. We take this as proof that outstanding quality and sustainable management are enshrined in the DNA of the Giesser family.

GIESSER – knives that last. Industry and catering professionals from more than 105 countries appreciate the reliability of our products. But we do not rest on our laurels. Creating value for our customers is our raison d’être. We constantly expand our product portfolio and are at the forefront of progress when it comes to function, form and the economical use of resources. Such is the duty of tradition.

We are pleased to present to you the latest issue of our catalogue, a splendid selection of new knives and the same high quality you have come to expect.

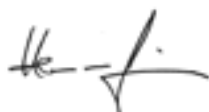

Hermann Giesser  
Managing Director



Hans-Joachim Giesser  
Managing Director

“  
Our knives are solid,  
honest, highly functional  
implements for your  
everyday needs.  
“



## Knife factory

The history of our brand An interview with Hans-Joachim and Hermann Giesser	06
GIESSER at a glance Facts and figures	14
The present Employees and manufacture	16
Manufacturing stages	24
Materials Steel and handles	26
Our favourites	30
PremiumCut	32
BestCut	34
PrimeLine	36

## GIESSER products

Before you order	
The anatomy of a knife	40
The colour code	42
<b>Butcher knives</b>	44
<b>Kitchen knives</b>	70
<b>Accessories</b>	128
<b>Service</b>	168
Cleaning	170
Sharpening	172
Knife management	174
Customisation	176



GIESSER



Week 2

15

Unit

Hans-Joachim and Hermann Giesser talk about the history, culture and plans of the GIESSER Messerfabrik knife factory.

## Johannes Giesser Messerfabrik. Then as now.



Hermann Giesser (left) oversees the manufacture while Hans-Joachim Giesser (right) is in charge of sales.

“We only make knives that we would love to keep for ourselves.” That is the maxim that underpinned the foundation of GIESSER more than two centuries ago. Today, Hans-Joachim Giesser is quick to emphasise: nothing has changed. He and his brother Hermann are the sixth generation of Giessers managing the traditional knife factory, and they are ready for the future. “We are running an authentic, family-run company that has grown slowly and healthily out of a passion for precision. The knives we create with our 130 employees are honest, solid, durable work tools.” It is plain to see that the two Swabian specialists believe in manufacturing excellent products from high-quality

materials, strive for consistent reliability and have a passion for product development. Their company and family, both deeply committed to their values, grew organically over time:

What started in a small forge in 1776 has become one of the world’s leading suppliers of quality knives and accessories. Every day, more than 8,000 professional knives are produced at the factory in Winnenden. The Giesser product catalogue comprises more than 2,500 forged and stamped knives and accessories for the food processing industry.





Since the early 1980s, the company's global sales have risen sevenfold. Butchers and caterers have sworn by GIESSER knives for decades. "Side by side, year by year," Hans-Joachim Giesser remarked. GIESSER moves with the times and adapts to the needs of its customers.

"Personal contact with our customers is extremely important to us. We seek dialogue and are grateful for criticism, as it allows us to keep improving and advancing our products."

Functional does not equal boring: for several years, the company has been striving to make its knives visually appealing with beautiful designs of excellent craftsmanship.



**Top** Solid growth requires more employees and new production facilities. In 2016, GIESSER moved to its new, high-tech building in Winnenden-Hertmannsweiler.



“We want our customers to enjoy holding our knives in their hands and looking at them,” the Managing Director says and goes on to explain the future of the Giesser family:

“Our new ‘PremiumCut’ series has stirred emotions. Specialist butchers and five-star chefs all over the world have shared their enthusiasm with us. We are currently exploring ways of producing our knives more sustainably to complement our economical use of resources.” GIESSER has clearly carved out a niche for itself in the food processing

and catering industries. One thing is certain: The 2018 conversion of the old Winnenden factory to a PremiumCut manufacture was both a milestone and a stepping stone to the future.

“We absolutely rely on our long-term industry partners, but PremiumCut also helps us address potential new target groups. Everyone’s cut out for GIESSER knives, we’re sure of that.” The long tradition of the Giesser family remains on a firm growth trajectory.



**Top** High-quality blade blanks from chromoly steel in more than 2,000 designs.



“When we were kids, we spent a lot of time in the production hall. We were always surrounded by knives! Our parents taught us to respect knives, not to fear them.”

**Top** Hans-Joachim Giesser at a packing station. His goal: to keep optimising GIESSER's economical use of resources.

**Left** Product presentation. An attractive appearance and beautiful, high-quality designs are paramount to GIESSER.



“We believe that sustainability is a business virtue. It goes without saying that our production is as environmentally friendly as possible.”



**Left** Processing and self-sufficiency. Heat is transformed in the engine room.

GIESSER has embraced sustainability on all levels as a fundamental virtue and a part of progressive management. We are committed to recycling resources such as exhaust heat and water in our manufacture. “Our advantage is that we only work with three materials: steel, plastic and wood,” Hans-Joachim Giesser explains with regard to the company’s sparing use of resources. All waste steel is recycled in full; some of it is melted down and reused. We also recycle coloured plastics. Once mixed into black plastics, they become virtually invisible and make excellent handles.

Hans-Joachim Giesser proudly emphasises: “Our methods are at the cutting edge of sustainability.” And he wants to go even further. GIESSER is considering various approaches to optimising its knife disposal system, for example. It will be a long process, but we are tackling the task with confidence and optimism. When it comes to staff management, our guiding principles are loyalty and fairness: wherever possible, we offer permanent employment to our apprentices and guarantee them durable, solid work in the Giesser family.



**Left** Promoting continuous improvement – Hermann Giesser in a discussion with Adrian Popa (centre) and Patrick Buckel (right).

**Bottom** Recycling at GIESSER: Once mixed into black plastics, the colourful plastic flakes become virtually invisible and make excellent handles.



# Some facts for you.



Johannes Giesser laid the foundation for GIESSER and started the manual production of knives and other cutting tools.

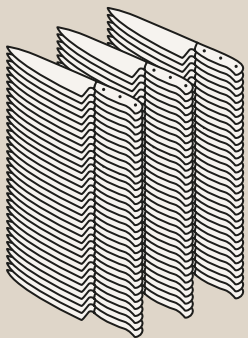

# 8.000

The GIESSER Messerfabrik produces more than 8,000 knives every day.

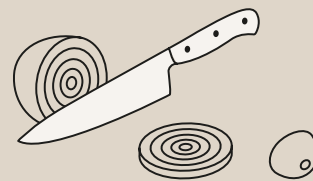

Today, GIESSER is one of the world's leading manufacturers of quality knives and accessories. Its customers are mainly professionals from the food processing and catering industries.

## A history of success

1776



In 1776, Johannes Giesser laid the foundation for GIESSER and started the manual production of knives and other cutting tools.

1865



Opening and commercial registration of a specialist shop for steel products, including on-site production facilities. After 1934: production of fixed-blade hand knives.

1934

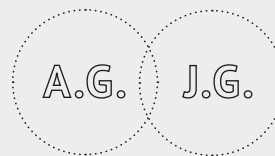

Production of hand knives. The company split into the Alfred Giesser Messerfabrik, which produced machine blades, and the Johannes Giesser Messerfabrik. In 1936, Giesser and Böhler Edelstahl jointly develop stainless blade steel.

1961



The Johannes Giesser Messerfabrik celebrated the opening of its first expansion building.

# 12



GIESSER produces knife handles in twelve standard colours. The HACCP colour coding allows our customers to distinguish between knives for different departments, shifts or foods.

# 1050 °C

GIESSER's most durable knives are made from first-class chromoly steel and hardened in a vacuum furnace at 1050 °C. This is one of the world's most advanced hardening technologies.



# 2.500

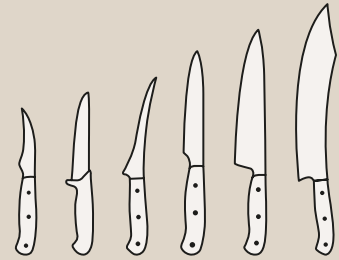

The extensive Giesser product catalogue comprises more than 2,500 forged and stamped knives and accessories for the food processing industry.



## PremiumCut

Solid designs, precise sharpness and quality workmanship: the new GIESSER PremiumCut series excels at all levels. You only need to look at them to understand our fascination with these impressive tools.

# 130

GIESSER currently employs 130 members of staff.

(As at April 2019)

1981

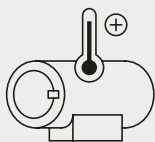

The first vacuum hardening plant caused a rapid improvement in product quality. It considerably increased the cutting-edge retention of the knives.

2000

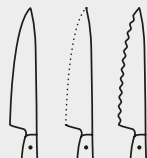

GIESSER continued to expand and optimise its product catalogue, offering the right tool for any cut.

2016



The company moved to its new, high-tech building in Winnenden-Hertmannsweiler.

2018



The old Winnenden factory was transformed into a 'PremiumCut manufactory'.



In the warehouse. Polished blades await processing.





The GIESSER production.  
**Of knives and men.**

From the handle to the blade: our knife factory in Winnenden works with the utmost precision, every step of the way.



Three factors matter when it comes to producing a high-quality kitchen or butcher knife: the basic materials, the hardening method and the final processing.

What is most important, however, are the people behind the product. Every day, they operate our cutting-edge machines and produce more than 8,000 GIESSER knives. The Giesser family consists of 130 motivated employees.

Joseph is one of them. For the past two years, he has been sharpening and testing blades for GIESSER. His work starts at 6 AM. Joseph values the Giesser family as a reliable employer, and he is fully convinced of the products to which his work contributes.

“A knife must be sharp, durable and comfortable to use.”

“I like the tomato knife best. It’s nice and small and handy.” He has given one to his wife, who appreciates it just as much and uses it in the kitchen all the time. With a laugh, he adds: “My wife just loves this knife. And it’s her opinion that counts for me.”





**Top** GIESSER produces more than 8,000 knives every day. Alex and his colleagues check each of them individually.



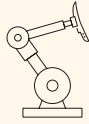

**Left** Focused work at the grinder.  
Pascal loves his work and gives it  
a hundred per cent.



Pascal completed his apprenticeship with GIESSER before starting full-time employment as a cutting-tool mechanic three years ago. At GIESSER, he has found his calling: "I am working with two grinding robots. This is brand-new technology. Producing knives in this way is special; it's not something everyone can do!"

A true technology aficionado, Pascal is excited about the future of knife production and his own future in the company. Technological progress, the sustainable use of resources and considerate staff management go hand in hand here.





DOMENIQUE  
(APPRENTICE)

**“A lot of people underestimate my work and think it’s boring. It really isn’t. How many people can say of themselves that they know how to make a knife with their own hands? I sure can.”**

# Taking traditional values into the future: GIESSER apprentices learn the time-honoured art of knife-making from scratch. It's an indispensable qualification.

**Right** Dominique at his workbench. He is proud to be learning a traditional trade.

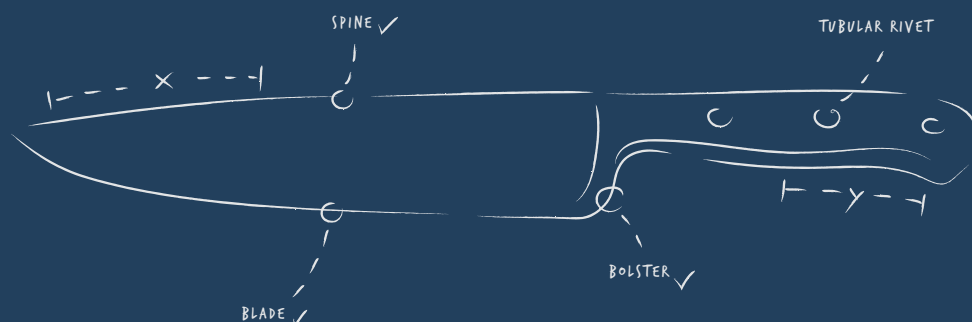

GIESSER is one of Germany's top-rated providers of apprenticeships. Our apprentices regularly receive awards in federal state competitions for young tradespeople. That's no coincidence: our training concept merges tradition with progress. We teach every step of the traditional art of knife-making in depth. Only after mastering those essential skills do apprentices proceed to the production facilities, which operate state-of-the-art machines and robots today. Dominique, a final-year apprentice

cutting-tool mechanic at GIESSER, appreciates the foundation training: "It is an incredibly exciting profession. I learn a lot about craftsmanship and get to make my own knives." Dominique's favourite item is a pocket knife which he produced during his apprenticeship. After his examination, he will possess a certified wealth of knowledge that qualifies him to operate the production facilities. Technological progress on a traditional foundation.

# Sharpened steel.

## How professional knives are made.



### MATERIAL

The blade blanks are stamped out of first-grade chromoly steel, which offers excellent cutting-edge retention.



### VACUUM HARDENING

To achieve the best possible cutting-edge retention, blades must be hardened evenly. We use one of the most advanced hardening technologies in the world: vacuum heat treatment.



### SHARPENING

The machine automatically pre-sharpens the blades with great precision. Two additional sharpening processes are required to achieve the perfect degree of sharpness.



### POLISHING

Our polishing machine bestows shine and lustre on the blades. It makes their surface perfectly smooth. This improves the quality of the blades, making them rust-proof and easy to clean.

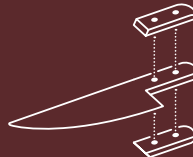

### HANDLES

We have the best handle for any application. Perfect ergonomics and anti-slip properties are our greatest priority when it comes to handles. Colour-coded handles improve hygiene standards in the food-processing industry.



### MANUAL FINISH

We manually finish our blades for perfect, long-lived sharpness. Our etching signals outstanding quality.





# Steel and handles.

Our painstakingly hand-picked materials make GIESSER knives true masterpieces.

## CHROMOLY STEEL

The steel GIESSER processes is produced in Germany, Austria and France. Virtually all knives are made from high-alloyed stainless steel.



It consists of the following main components:

### CARBON (C)

influences sharpness and cutting-edge retention, proportion: 0.5–0.6%

### CHROMIUM (CR)

improves the rust resistance of the steel, proportion: 14%

### VANADIUM (V)

boosts material stability, proportion: 0.1–0.2%

### MOLYBDENUM (MO)

improves the rust resistance of the steel, proportion: 0.5–0.8%

### PRIMELINE

Soft handles keep you from tiring while you work. They are easy on your joints and boost your productivity. The solid hand guard protects your hands from sliding into the blade. PP core, TPE coating.

### TPE

A thermoplastic elastomer with excellent anti-slip properties.

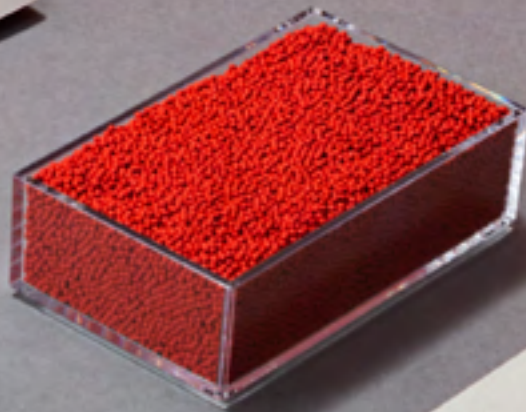

### PP

Our alternative handle material: polypropylene reinforced with glass fibre.

## OLIVE WOOD

Olive wood feels warm and pleasant in your hand. At the same time, it is extremely hard and repels moisture. From strictly controlled forests and growing regions. FSC-certified.



## PSU

This especially resilient material can withstand temperatures of up to 200 °C (for a short time). It is a plastic specially developed for the food-processing industry.

## KOTIBÉ

Kotibé is a highly resilient, hard wood. Its natural texture allows you to hold the handle securely even when it is covered in grease or water. From strictly controlled forests and growing regions. FSC-certified.





#### POLYOXYMETHYLENE

Polyoxymethylene is a highly stable, durable plastic. The triple-rivet plastic handle offers a secure grip for any professional kitchen tasks. It is compliant with the German Consumer Goods Ordinance for Food, of course.



#### HVI: LIGHT PURPLE

The knife handle is made from polypropylene, a specially developed plastic that is free from animal substances. It is ideal for vegan, allergen-free cooking. Similarly, it can be used in environments that produce halal food.

#### DET

The handle consists of plastic mixed with metal particles. This makes the material detectable. Knives with DET handles reduce process risk in meat processing.



“We spent a lot of time tweaking these product lines before they were perfect for their specific fields of application. They’re absolutely flawless now!”



## Our favourites.

GIESSER produces more than 2,500 types of knives. Each of them has its unique strengths and is an indispensable part of our product range. Three product families have become our absolute favourites, and we have honed them to perfection: our PremiumCut knives have great designs and lots of personality, while BestCut knives are unparalleled in quality. The PrimeLine series offers innovative kitchen and industry knives.



### **PREMIUMCUT**

For all professionals, cooking enthusiasts and barbecue lovers who like a touch of class.

Page 32



### **BESTCUT**

Extremely sharp knives with ergonomic handles and extraordinary cutting-edge retention.

Page 34

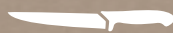

### **PRIMELINE**

Perfect for any work in the meat processing and catering industries.

Page 36

Impressive! Solid knives of outstanding quality with special designs for barbecue lovers, star chefs and steak connoisseurs.

## Our most passionate range: PremiumCut



“The feedback from our customers has been overwhelming. Meat sommeliers everywhere are impressed by PremiumCut. We’ve nailed the trend!”

A striking design and the touch of a true expert make the knife creations in our PremiumCut series what they are. The machete idea came from a seasoned professional: Ralf Jakumeit, the “rocking” celebrity chef. With his help, we worked meticulously on every single detail, from the sturdy blades to the extraordinary handle design.

These knives are a sight to behold and a pleasure to handle, whether you’re a professional or a hobby chef. We offer four handles to combine with the ten blades. All of them are made from carefully selected materials, such as Thuja wood or Micarta.





For barbecue lovers and  
classy connoisseurs:  
PREMIUMCUT.

### 1 THE BLADE

The blades in our PremiumCut range are extraordinarily sharp and hard – for perfectly precise cuts.

### 2 THE HANDLE

Strikingly beautiful materials, such as arborvitae wood and Micarta, give our knives their inimitable appearance.

### 3 ROCKING CHEFS

“Rocking Chefs” are chefs who are open to the extraordinary and keen to take experimenting to extremes. The naturally elegant Micarta is perfect for them: no two handles are alike.



The masterpieces among our chef's knives. BestCut knives offer top quality, absolute precision, excellent cutting-edge retention and indestructible rust resistance.

## The perfectionists: BestCut



Forged from a single piece of steel, enriched with large amounts of carbon (X55) and vacuum-hardened to HRC 56–57: our BestCut knives slide through any material safely and without slippage. Their special cut can penetrate even the hardest peels and crusts. To ensure optimal handling of our ergonomically shaped handles,

we have chosen a velvety finish for the surface with excellent grip. BestCut knives meet the highest requirements. Three stainless-steel rivets securely hold the two grip plates together. Their especially resilient material can withstand temperatures of up to 200 °C (for a short time).

### 1 THE SERIAL NUMBER

Unique and consecutive. A quality seal that allows us to identify and track our products and offer our warranty.

### 2 THE HAND GUARD

Its slightly rounded edges and oblique shape make for perfect handling.

### 3 THE HANDLE

With its ergonomic shape and soft edges, each of our handles is a true pleasure to (be)hold.



The long cutting-edge retention of our BestCut X55 blades

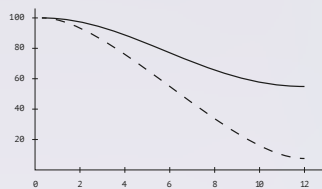

— BestCut X55 blade  
- - - Conventional blade



A sturdy companion for any task in private and industry kitchens. Perfect for everyday use.

## Our most innovative range: PrimeLine

Professionals in the catering or food processing industry require perfectly sharp, hygienic, safe and reliable knives. In short, they need our innovative PrimeLine series. A wide range of blades with various shapes and lengths, sturdy or flexible blades and short or long hand guards make PrimeLine the ideal choice for any type of catering or meat processing task. We have paid particular attention to the perfect balance and

proportions between the blade and the handle to prevent fatigue while cutting. The rounded handles, all with guard, ensure that PrimeLine knives are pleasant to hold and are easy on your tendons and joints. Made from soft plastic, the handles adapt to the shape of your hand. They offer brilliant stability and precision even when your hands are damp.



Meat, fish, fruit, vegetables  
– PrimeLine knives deal with  
them all.



### 1 THE BLADE

To achieve the best possible cutting-edge retention, we heat-treat our knives in a vacuum – the world’s most advanced hardening technology.

### 2 NON-SLIP HANDLE

The pleasant plastic adapts to the shape of any hand.

### 3 TWO HANDLE OPTIONS

PrimeLine knives are available with a short or a long hand guard.

Short hand guard



Long hand guard





---

040 – 043

## Before you order

The anatomy of knives...040  
Colour codes .....042

---

044 – 069

## Butcher knives

Standard handle .....046    No.9 .....064  
Scalloped edge .....055    Eagle.....065  
PrimeLine .....058    Bodyguard.....066  
No.4 .....063    No.PP7.....067  
Scandic .....063    DET .....068

---

070 – 127

## Kitchen knives

BestCut .....072    Primeline ..... 084    Fish knives .....109  
BestCut olive wood ....075    Stamped chef's knives .. 088    PremiumCut ..... 114  
Forged chef's knives ....076    Light purple .....099    Steak cutlery ..... 126  
Wooden handle.....079    Pastry knives..... 101  
POM handles ..... 082    Chees knives ..... 106

---

128 – 167

## Accessories

Accessories .....130  
Sharpening .....147  
Storage .....154  
Knife blocks .....160  
Protection .....162

---

168 – 177

## Service

Cleaning .....170  
Sharpening .....172  
Knife management .....174  
Personalisation .....176

---





## SHARPENING

GIESSER offers the perfect cut for any circumstance. You can also choose from a wide range of blade shapes and lengths.

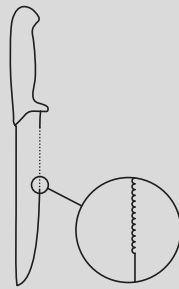

### AW PARTIALLY SERRATED

The 4 cm serration can cut through the toughest plastic sausage casing.

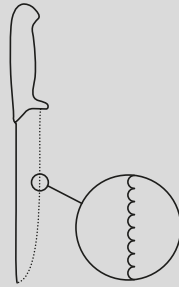

### W WAVY-EDGED

The wavy blade securely and effectively cuts through hard shells and crusts.

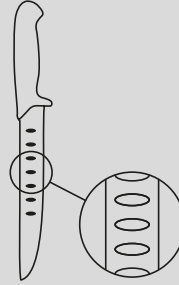

### WWL SCALLOPED

A knife with a scallop-sided blade slides through any material easily. It cuts efficiently with minimal effort.

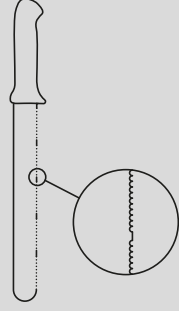

### Z SERRATED EDGE

For cutting fruit and vegetables with skin or a harder peel. The blade effortlessly cuts through peel without squashing soft or delicate produce.

Security and hygiene are paramount wherever food is processed.

## The colourful world of GIESSER products.

GIESSER uses HACCP colour coding to help customers distinguish between knives for different departments, shifts or foods. Our hygienic knife boxes in various sizes also facilitate separation by department and protect the knife as well as its owner.

### Possible allocation

#### COLOUR CODES BY DEPARTMENT

COLOUR	DEPARTMENT
● RED	Beef
● YELLOW	Pork
● GREEN	Lamb

#### COLOUR CODES BY SHIFT

COLOUR	SHIFT
● RED	1st shift
● BLUE	2nd shift
● YELLOW	3rd shift

### Our suggested allocation

#### COLOUR CODES BY DEPARTMENT

COLOUR	DEPARTMENT
● WHITE	Bakery and dairy
● YELLOW	Cooked food
● RED	Raw meat
● BLUE	Raw fish
● GREEN	Fruit and vegetables
● BROWN	Root vegetables

COLOUR	DEPARTMENT
● LIGHT PURPLE	Halal processing
● LIGHT BLUE	as needed
● LIME	as needed
● ORANGE	as needed
● PINK	as needed
● PURPLE	as needed



**Top** The consistent adherence to HACCP combined with hygienic plastic cutting boards in corresponding colours inspires confidence in customers and consumers.

#### **1 DEVELOPMENT**

Experienced toolmakers, product designers and our own customers help us develop new handle shapes for even greater security and productivity at work.

#### **2 HYGIENE**

All colour-coded handles comply with the applicable hygiene and security regulations.

#### **3 CATALOGUE**

GIESSER offers the largest catalogue of colour-coded handles. The coloured dots next to the individual articles indicate serial availability.

#### **4 CUSTOM-MADE KNIVES**

Have you set your mind on a knife that is not available in the standard colour you need? GIESSER will custom-make your perfect knife as a minimum batch of just 60 items.

#### **5 CUSTOMISED COLOURS**

If you order 2,000 items or more (5,000 items in case of customised knives), we can produce your knives in customised colours (e.g. your company colour or as promotional gifts).

#### **6 QUALITY**

We carefully control all process steps to guarantee the consistently high quality of our products.



# Butcher knives

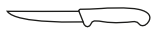

## STANDARD HANDLE

A standard plastic handle made from anti-slip material for safe, comfortable handling (TPE).

046 - 054



## SCALLOPED

A knife with a scallop-sided blade slides through any material easily. It cuts efficiently with minimal effort.

055 - 057



## PRIMELINE

The two-component soft handles keep you from tiring while you work. They are easy on your joints and boost your productivity.

058 - 061



## NO. 4

A handle made from anti-slip material for safe, comfortable handling. The open end of the handle makes it easy to switch quickly from the standard grip to the underhand position.

063



## SCANDIC

An extended hand guard for greater security. The especially long, medium-volume grip ensures perfect handling, especially for users with larger hands.

063



## NO. 9

A handle made from anti-slip material for safe, comfortable handling. The open end of the handle makes it easy to switch from the underhand position to the standard grip.

064



## EAGLE

Especially pronounced hand guard. Prevents the leading hand from sliding and provides greater security.

065



## BODYGUARD

A protective ring prevents the leading hand from sliding off the handle while cutting. Medium-volume handle.

066



## NO. PP7

This handle offers optimal grip and is ideal for preventing fatigue during work in the meat and fish processing industry and other food processing fields.

067



## DET

The handle consists of plastic mixed with metal particles. This makes the material detectable. Knives with DET handles reduce process risk in meat processing.

068

# Standard handle

## 1 SAFETY

The protective guard prevents the hand from slipping when holding the knife.

## 2 ERGONOMICS

Average-size handle made from material that offers excellent slip resistance and is easy to grip.

## MULTI-FUNCTIONAL

The standard handle is suitable for almost all applications.



**2005**  
Breaking knife

- 7 inch ●
- 7 3/4 inch ●●●●●
- 8 3/4 inch ●●●●●
- 9 3/4 inch ●●●●●



**2015**  
Cimeter knife

- 6 1/4 inch ●
- 7 inch ●●



**2015**  
Cimeter knife

- 10 1/2 inch ●
- 11 1/4 inch ●
- 14 1/4 inch ●



**2025**  
Skinning knife

- 6 inch ●●
- 7 inch ●●



**2105**  
Skinning knife

- 5 inch ●●
- 6 1/4 inch ●●
- 7 inch ●●●●●
- 8 1/4 inch ●●●●●



**2405**  
Butcher knife

6 ¼ inch      7 inch  
● ●              ● ●



**2275**  
Filleting knife

7 inch              8 ¼ inch  
● ●              ● ● ●



**2285**  
Filleting knife | flexible blade

7 inch              8 ¼ inch  
● ●              ● ●



**2605**  
Boning knife

6 inch              7 inch  
● ● ● ● ○      ● ●



**2505**  
Boning knife | medium

4 inch              5 inch              6 inch              6 ¼ inch  
● ●              ● ● ● ● ○ ●      ● ● ● ● ●      ● ●



**2615**  
Boning knife | pointed, flexible

6 inch  
●



**2515**  
Boning knife | stiff

5 inch              6 inch              6 ¼ inch  
● ● ● ● ●      ● ● ● ● ○ ●      ● ● ● ● ●



**2535**  
Boning knife | highly flexible  
5 inch      6 inch  
● ● ● ● ● ●      ● ● ● ● ● ●



**3105**  
Boning knife  
4 inch      5 inch      6 1/4 inch  
● ●      ● ● ● ● ● ○ ●      ● ● ● ● ● ○ ●



**3105**  
Boning knife  
7 inch      8 1/4 inch  
● ● ● ● ●      ● ●



**3115**  
Boning knife  
6 inch  
●



**3145**  
Boning knife | narrow  
5 inch      6 1/4 inch  
●      ●



**3165**  
Boning knife  
4 1/4 inch      5 1/2 inch      6 1/4 inch      7 inch  
●      ● ● ● ● ●      ● ● ● ● ● ○ ●      ● ● ● ●



**3185**  
Poultry knife  
4 inch  
● ● ● ● ●



**3186**  
Poultry knife  
4 1/4 inch  
● ●





**3215**  
Boning knife | flexible  
6 inch  
● ●



**3215 9,5 e101**  
Boning knife | small handle  
●



**3005**  
Sticking knife  
5 inch ● ● ● ● ●  
6 1/4 inch ● ● ● ● ● ○ ●  
7 inch ● ● ● ● ● ○ ●



**3005**  
Sticking knife  
8 1/4 inch ● ● ● ● ●  
9 1/2 inch ● ● ● ● ●  
11 1/4 inch ● ●



**3085**  
Sticking knife  
4 inch ● ● ● ● ●  
5 inch ● ● ● ● ●  
6 inch ● ● ● ● ●



**3085**  
Sticking knife  
7 inch ● ● ● ● ●  
8 1/4 inch ● ● ● ● ●  
9 1/2 inch ● ● ● ● ●



**3305**  
Sticking knife | stiff, facet  
6 1/4 inch ●  
7 inch ●



**3405**  
Tripe knife | steel button  
6 1/4 inch ●  
7 inch ●



**3425**  
Tripe knife | plastic button  
6 1/4 inch  
●



**3426**  
Tripe knife | steel button  
6 1/4 inch  
● ●



**3427**  
Tripe knife  
8 1/4 inch  
●



**4005**  
Butcher knife  
6 1/4 inch    7 inch    8 1/4 inch  
● ●    ● ● ● ●    ● ● ● ● ○



**4005**  
Butcher knife  
9 1/2 inch    10 1/2 inch    11 1/4 inch  
● ● ● ● ●    ● ● ● ● ●    ● ●



**4025**  
Butcher knife | narrow shape  
6 1/4 inch    7 inch    8 1/4 inch    9 1/2 inch  
● ● ●    ● ● ● ● ●    ● ● ● ● ● ○ ●    ● ● ● ● ● ○ ● ● ●



**4025**  
Butcher knife | narrow shape  
10 1/2 inch    11 1/4 inch    12 1/2 inch    14 1/4 inch  
● ● ● ● ●    ● ● ● ● ●    ● ●    ● ●



**4035**  
Meat slicer  
8 1/4 inch  
● ●



**5005**  
Bacon knife  
12½ inch  
●



**5065**  
Block knife  
8¼ inch    10¼ inch    12½ inch    14¼ inch  
●    ●    ●    ●



**6005**  
Steak knife  
8¼ inch    9½ inch    10½ inch    11¼ inch  
● ● ● ● ●    ● ● ● ● ●    ● ● ● ● ●    ● ● ● ● ●



**7105**  
Ham knife  
11 inch  
● ●



**7105 w**  
Ham knife, wavy edge  
11 inch  
●



**7305**  
Slicer  
8¼ inch    9¾ inch    11 inch    12¼ inch  
● ●    ● ● ●    ● ● ●    ● ●



**7305 w**  
Slicer | wavy edge  
8¼ inch    9¾ inch    11 inch    12¼ inch  
● ●    ●    ●    ●



**7305 st**  
Slicer | stiff blade, 2.7 mm  
15¼ inch    17¾ inch    19 inch  
●    ●    ●



**7305 aw**

Slicer | partly serrated

8 1/4 inch



9 1/4 inch



11 inch



**7365**

Filleting knife

6 1/4 inch



7 inch



7 1/4 inch



8 1/4 inch



**7705**

Slicer

8 1/4 inch



9 1/4 inch



11 inch



12 1/4 inch



**7705**

Slicer

14 1/4 inch



**7705 w**

Slicer | wavy edge

9 1/4 inch



11 inch



12 1/4 inch



14 1/4 inch



**7705 aw**

Slicer | partly serrated

9 1/4 inch



11 inch



**7745**

Melon knife

13 1/4 inch



**7905**

Salami slicer

11 1/4 inch





**7905 w**  
Salami slicer | wavy edge  
11¾ inch  
●



**7925**  
Salami slicer  
14¾ inch  
●



**7935**  
Serrano knife  
11¾ inch  
●



**7945**  
Sausage knife  
8¾ inch  
●



**7945 aw**  
Sausage knife | partly serrated  
8¾ inch  
● ●



**7965**  
Sausage knife  
8¾ inch  
●



**7965 aw**  
Sausage knife | partly serrated  
8¾ inch  
● ● ●



**7965 w**  
Sausage knife | wavy edge  
8¾ inch  
●



**4065**  
Sausage pricker

- 



**4056-6**  
Sausage production knife

- 



**7725**  
Kebab knife  
17 3/4 inch

- 



**7755**  
Kebab knife | extra broad  
17 3/4 inch      21 3/4 inch

- 

-

# Scalloped edge

## 1 IMPROVED CUTTING

By air cushion between blade and meat.

## 2 PRODUCTIVITY

Scalloped knives effortlessly slice through the material being cut, providing a perfect cut that is easy and quick to achieve.



**2005 wwl**

Breaking knife | scalloped edge

7 1/4 inch



8 3/4 inch



9 1/4 inch

**2105 wwl**

Skinning knife | scalloped edge

6 1/4 inch



7 inch



8 1/4 inch

**2505 wwl**

Boning knife | scalloped edge, medium

5 inch



6 inch

**2515 wwl**

Boning knife | scalloped edge, stiff

5 inch



6 inch



6 1/4 inch

**2535 wwl**

Boning knife | scalloped edge, highly flexible

5 inch



6 inch

**2605 f wwl**

Skinning knife | scalloped edge, flexible

6 inch

**2605 wwl**

Boning knife | scalloped edge

6 inch



7 inch

**3005 wwl**

Sticking knife | scalloped edge

6 1/4 inch



7 inch







**3105 wwl**

Boning knife | scalloped edge

5 inch      6 1/4 inch  
●              ●



**4005 wwl**

Butcher knife | scalloped edge

8 1/4 inch      9 1/2 inch  
●              ●



**4025 wwl**

Butcher knife | scalloped edge

8 1/4 inch      9 1/2 inch      10 1/2 inch  
●              ● ● ● ●              ●



**6005 wwl**

Steak knife | scalloped edge

8 1/4 inch      9 1/2 inch  
●              ●



**7305 wwl**

Slicer | scalloped edge

8 1/4 inch  
●



**7305 wwl aw**

Slicer | scalloped edge, partly serrated

8 1/4 inch  
●



**7705 wwl**

Slicer | scalloped edge

9 3/4 inch      11 inch      12 1/4 inch      14 1/4 inch  
●              ●              ●              ●



**2008 wwl**

Steak knife | scalloped edge

9 3/4 inch  
● ●

# Primeline

PrimeLine features are inspired by nature, making this knife series particularly ergonomic, hygienic, sharp and slip-resistant. Various blade shapes and lengths, flexible or stiff blades, as well as the option of a shorter or longer handle guard make PrimeLine the perfect choice for all areas of food service, meat processing and food processing.

## 1 SERIALLY NUMBERED

## 2 AMAZINGLY ERGONOMIC

Two different versions of handles with and without protection.

## 3 EXTRAORDINARILY SLIP-RESISTANT

Soft and slide-proof handle with a solid core for absolute stability.





**11250**

Boning knife | flexible

5 inch



6 inch



**11251**

Boning knife | stiff

5 inch



6 inch



**11253**

Boning knife | highly flexible

5 inch



6 inch



**11200**

Breaking knife

7 1/4 inch



**12200**

Breaking knife

8 1/4 inch



9 inch



**12200 wwl**

Breaking knife | scalloped edge

9 1/4 inch



**12250**

Boning knife | flexible

5 inch



6 inch



**12251**

Boning knife | stiff

5 inch



6 inch





**12251 wwl**

Boning knife | scalloped edge

6 inch



**12253**

Boning knife | highly flexible

5 inch

6 inch



**12260**

Boning knife

6 inch



**12260 wwl**

Boning knife | scalloped edge

6 inch



**12310**

Boning knife | flexible

5 inch

6 1/4 inch



**12316**

Boning knife

6 inch



**12300**

Sticking knife

6 1/4 inch

7 inch

8 1/4 inch



**12308**

Sticking knife

6 inch

7 inch





**12402**

Butcher knife

8 ¼ inch

9 ½ inch

10 ½ inch

•

•

•



**12600 ww1**

Breaking knife | scalloped edge

9 ½ inch

•



**12730**

Slicer

11 inch

•



**217705 w**

Slicer | wavy edge

9 ¾ inch

12 ¼ inch

•

•



**3511 pl**

PrimeLine set | 3 pcs., contents: 11250-13, 11250-15, 12200-22

•

## Our safety handles

Particularly distinctive handle guard. Prevents the hand from slipping when holding the knife and improves work safety. Average-size handle ensures fatigue-free work.

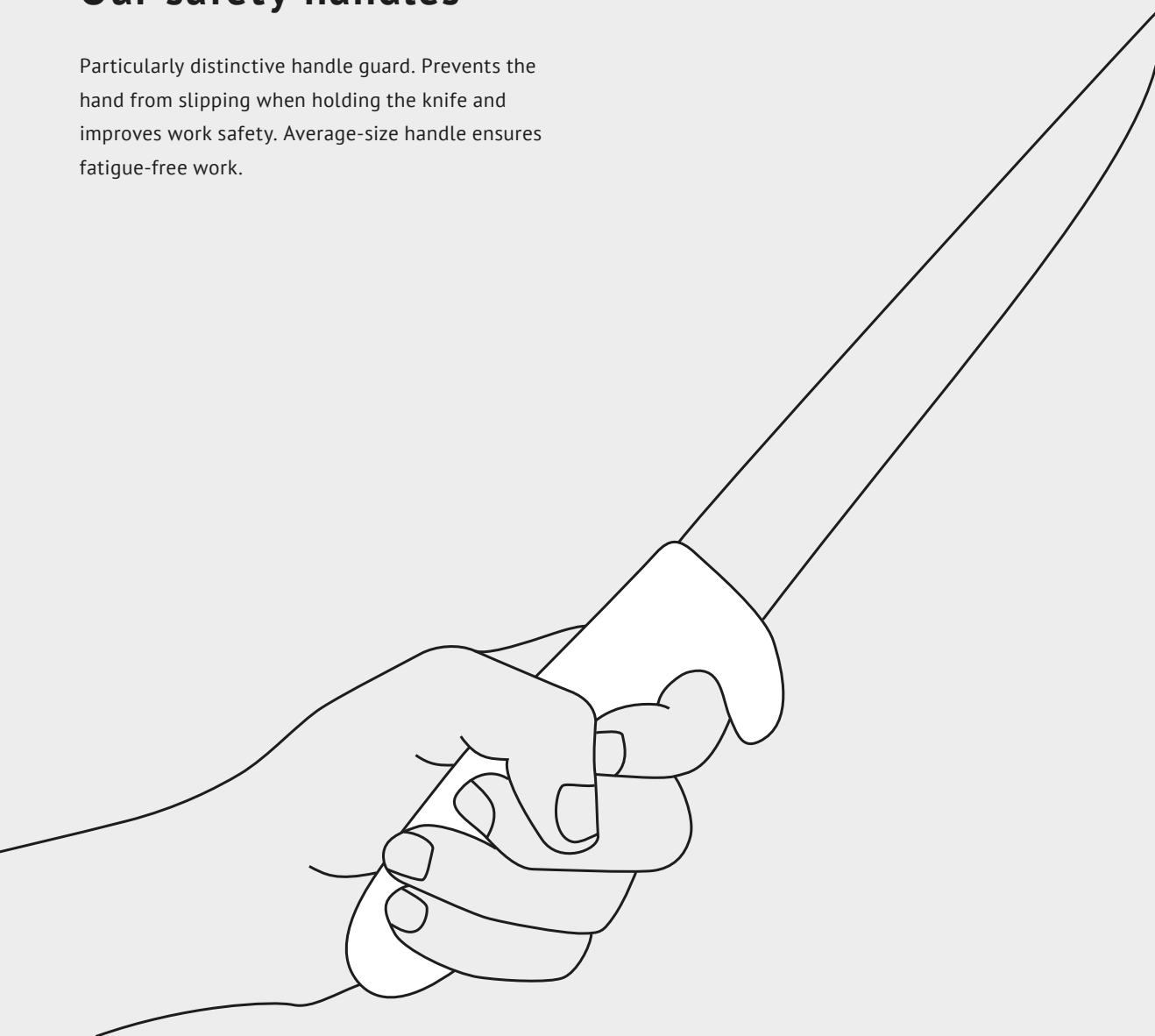

### Our safety handle selection

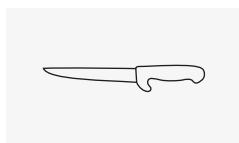
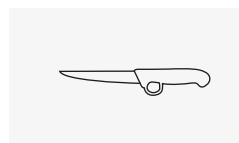
**NO.4****NO.9****SCANDIC****EAGLE****BODYGUARD**

## Handle No. 4

### 1 SAFETY

The rounded back of the handle provides an excellent grip.

### 2 PRODUCTIVITY

The open ended handle enables the user to effortlessly switch between a standard and trigger position.



### 2504

Butcher knife | ergonom. handle, medium

5 inch



### 2504

Butcher knife | ergonom. handle, medium

6 inch



## Safety handle „Scandic“

### 1 SAFETY

The extended protection prevents sliding.

### 2 ERGONOMICS

The particularly long handle is suitable for big hands.



### 2503

Boning knife | special handle, medium

6 inch



### 2603

Boning knife | special handle

6 inch



## Handle No. 9

### 1 MATERIAL

Very comfortable and slipproof thermoplastic elastomer (TPE).

### 2 ERGONOMICS

"American" handle for easy and quick changing of the grip – especially developed for boning knives.



### 2509

Boning knife | straight handle, medium

5 inch



6 inch



### 2519

Boning knife | straight handle, stiff

5 inch



6 inch



### 2539

Boning knife | straight handle, highly flexible

5 inch



6 inch



### 3169

Boning knife | straight handle

5½ inch



6¼ inch





# Safety handle „Eagle“

## 1 MATERIAL

Very comfortable and slipproof thermoplastic elastomer (TPE).

## 2 SAFETY

With particularly long protection that considerably reduces the risk of injury when cutting.



### 3002

Sticking knife

7 inch



8 ¼ inch



9 ½ inch



### 3082

Sticking knife

6 inch



7 inch



8 ¼ inch



9 ½ inch



## Safety handle „Bodyguard“

### 1 SAFETY

No sliding-off of the working hand possible.  
Highest safety when cutting and trimming meat.

### 2 MATERIAL

Very comfortable and slipproof  
thermoplastic elastomer (TPE).



### 2008 wwl

Breaking knife | BodyGuard handle, scalloped edge

9 3/4 inch



### 2008

Breaking knife | BodyGuard handle

7 inch

9 3/4 inch



### 3008

Sticking knife | BodyGuard handle

6 1/4 inch

7 inch

8 1/4 inch



### 3168

Boning knife | BodyGuard handle

6 1/4 inch



### 4028

Butcher knife | BodyGuard handle

9 1/2 inch



## Handle No. PP7

### 1 SAFETY

An ergonomic, comfortable handle.  
For a secure grip when processing meat.

### 2 MATERIAL

Our alternative to standard handles –  
glass-fibre reinforced polypropylene (PP).

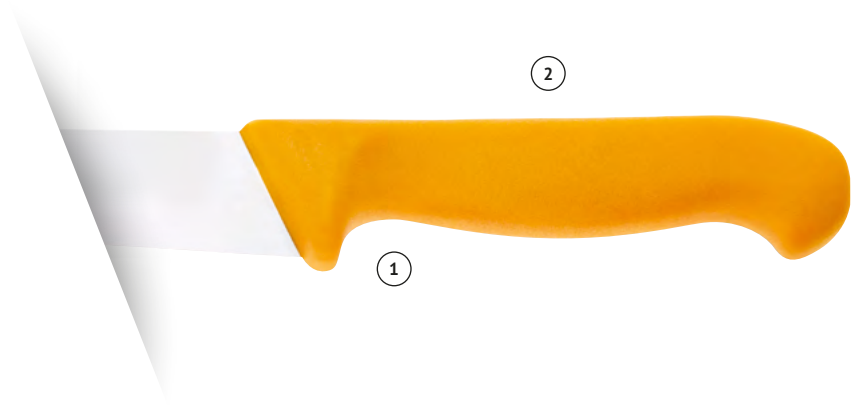

### 2507 pp g

Boning knife | medium

5 inch      6 inch



### 2517 pp g

Boning knife | stiff

5 inch      6 inch



### 3107 pp g

Boning knife | straight

6 ¼ inch



### 3167 pp g

Boning knife | straight

6 inch      11 ¼ inch



### 2007 pp g

Breaking knife

7 ¾ inch      9 ¾ inch



### 3007 pp g

Sticking knife

7 inch



## Detectable plastic handles

Improve safety boost  
product quality optimise  
hygienic standards



### 2005 det

Breaking knife | detectable

7 3/4 inch      9 3/4 inch

•

•



### 3005 det

Sticking knife | detectable

6 3/4 inch      7 inch

•

•



### 2505 det

Boning knife | detectable

6 inch

•



### 2515 det

Boning knife | detectable, stiff

5 inch

•





# Kitchen knives



## BESTCUT

This especially resilient material can withstand temperatures of up to 200 °C for a short time.

072 – 074

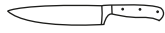

## BESTCUT OLIVE WOOD

Olive wood feels warm and pleasant in your hand. At the same time, it is extremely hard and repels moisture.

075

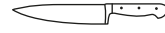

## FORGED CHEF'S KNIVES

A range of traditionally forged cooking knives with a POM handle. Available in many colours.

076 – 078

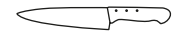

## WOODEN HANDLE

Its natural texture allows you to hold the handle securely even when it is covered in grease or water.

079 – 081



## POM HANDLES

The triple-rivet plastic handle offers a secure grip for any professional kitchen tasks.

082 – 083



## PRIMELINE

The continuous, red core gives the handle stability. Its coating is made from extra-soft plastic.

084 – 087



## STAMPED COOKING KNIVES

A standard plastic handle made from anti-slip material for safe, comfortable handling (TPE).

088 – 098

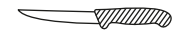

## LIGHT PURPLE

The knife handle is made from polypropylen, a specially developed plastic that is free from animal substances.

099 – 100



## PASTRY KNIVES

Our versatile baking and bread-making tools cover all your baking needs.

101 – 105

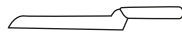

## CHEES KNIVES

The right products for all shapes and types of cheese.

106 – 108



## FISH KNIVES

From cod filleting knives to lobster crackers: GIESSER offers a wide range of fish processing products.

109 – 113



## PREMIUMCUT

Turn each cut into an experience. We care about knife handles and their finish just as much as we do about our blades.

114 – 125

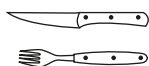

## STEAK CUTLERY

GIESSER steak cutlery is ideal for grilled meat and crispy crusts.

126 – 127

# BestCut

The silky soft handle fits particularly well and securely in the hand. The handles are firmly connected together with 3 stainless steel rivets.

The material is particularly durable and can even withstand temperatures of up to 200°C. (short-time contact).

## 1 THE BLADE

The blade combines extreme sharpness, durability and rust resistance.

## 2 SERIAL NUMBER

For allocation, tracking purposes and guarantee.

## 3 THE BOLSTER

Slightly rounded edges and bevelled towards the front to ensure perfect handling.

## 4 THE HANDLE

Ergonomic design with soft edges, perfect grip to ensure precise guidance, made of plastic specially developed for the food processing sector.







**8640**

BestCut paring knife

3 1/4 inch      4 inch

- 
- 



**8640 w**

BestCut paring knife | wavy edge

4 inch

- 



**8643**

BestCut bird's beak peeling knife

2 1/4 inch

- 



**8664**

BestCut filleting knife

7 inch

- 



**8670**

BestCut slicer

6 inch      7 1/4 inch

- 
- 



**8670**

BestCut slicer

9 1/4 inch

- 



**8670 w**

BestCut chef's knife | wavy edge

7 1/4 inch

- 



**8680 w**

BestCut chef's knife | wavy edge

9 1/4 inch

-



**8681**  
BestCut chef's knife | light version  
7 inch



**8661 w**  
BestCut universal knife | wavy edge  
9 1/4 inch

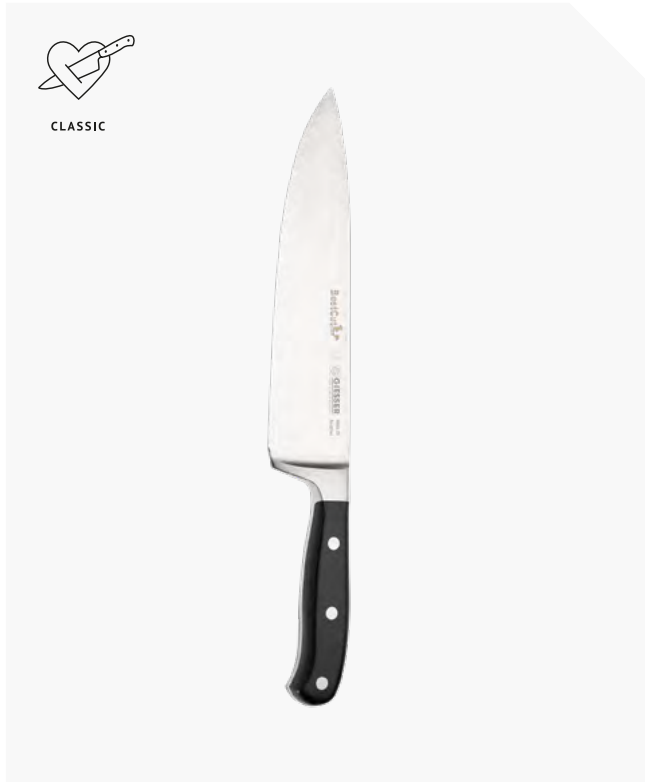

**8680**  
BestCut chef's knife  
7 1/4 inch      9 inch      9 1/4 inch



**8610 p**  
BestCut claw fork | forged  
6 1/4 inch



**9922**  
Chefcut | fine cut  
9 1/4 inch



**8291 b 8 bc**  
Knife bag BestCut | 8 pcs., contents: 8640-10, 8661 w-25, 8663-15, 8664-18, 8670-20, 8680-23, 9410 p-15, 9922-25



**8291 b 10 bc**  
Knife bag BestCut | 10 pcs., contents: 8210 p-26, 8640-8, 8640 w-10, 8643-6, 8661 w-25, 8670-25, 8680-23, 8681-18, 9410 p-15, 9922-25

# BestCut olive wood

## 1 CHARACTERISTICS

The olive wood handles are triple riveted. Olive wood feels pleasant and warm. Furthermore it's extreme hard and moisture repellent.

## 2 ERGONOMICS

Finely-tuned proportions make BestCut olive wood blades and handles perfectly balanced.



### 8260 w 20 o

Bread knife | wavy edge, olive wood handle

7 ¼ inch



### 8640 10 o

BestCut paring knife | olive

4 inch



### 8661 w 25 o

BestCut universal knife | olive

9 ¼ inch



### 8680 20 o

BestCut chef's knife | olive

7 ¼ inch



### 8670 15 o

BestCut slicer | olive

6 inch

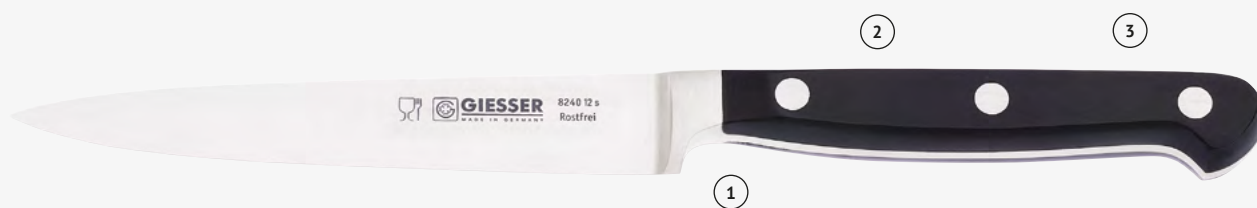

## Forged chef's knives

### 1 THE REFINEMENT

In eight steps the knife is smoothed to perfection. The honing by the hand of a master craftsman guarantees a perfect blade.

### 2 THE FORGING

From high grade chromemolybdenum steel the forged blank blade is manufactured in nine procedures.

### 3 THE HANDLE

For the forged cook's knives only high grade POM plastic scales are used.



**8240**

Paring knife

4 inch



4 3/4 inch



**8241**

Vegetable knife

3 3/4 inch



**8243**

Bird's beak peeling knife

3 1/2 inch



**8251**

Decorating knife

4 1/4 inch





**8244**  
Tomato knife | with tines  
5 inch  
●



**8263**  
Boning knife  
6 1/4 inch  
●



**8260 w**  
Bread knife | wavy edge  
7 3/4 inch  
●



**8264**  
Filleting knife  
7 inch  
● ● ● ● ●



**8269**  
Santoku knife  
7 inch  
●



**8270**  
Chef's knife | narrow  
6 inch ●      7 inch ● ● ● ● ●      7 1/4 inch ● ● ● ● ●



**8270**  
Chef's knife | narrow  
9 inch ● ● ● ● ●      9 1/4 inch ●



**8280**  
Chef's knife | wide  
6 inch  
● ● ● ● ●



**8280**  
Chef's knife | wide  
7 inch      7 1/4 inch  
● ● ● ● ●



**8280**  
Chef's knife | wide  
9 inch      9 1/4 inch  
● ● ● ● ●



**8280**  
Chef's knife | wide  
11 1/4 inch  
●



**8284**  
Bone splitter  
9 1/4 inch  
●



**8280 w**  
Chef's knife | wavy edge, wide  
9 1/4 inch  
●

# Wooden handle

## 1 CHARACTERISTICS

Kotibe is a particularly durable and hard wood. Thanks to its natural characteristics, a Bubinga handle offers an excellent grip even after it has been in contact with oil and water.

## 2 ERGONOMIE

The shape of the handle perfectly adapts to the shape of the hand.

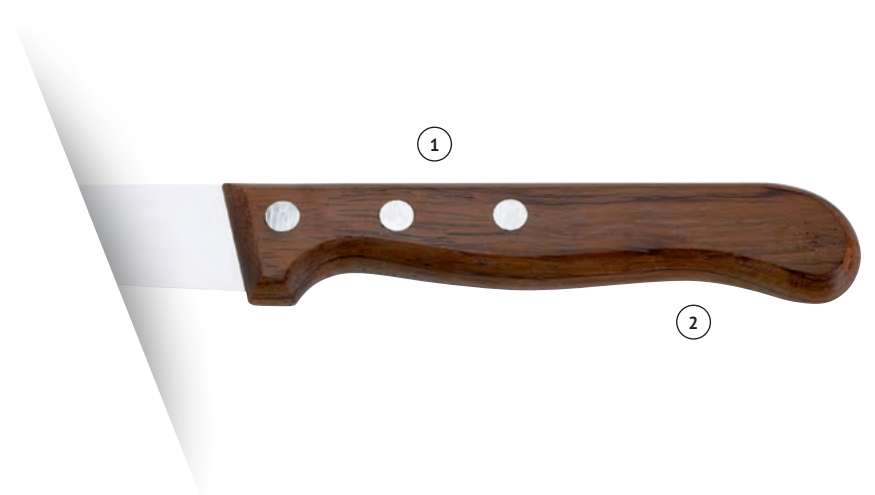

**2400**  
Butcher knife  
6 1/4 inch

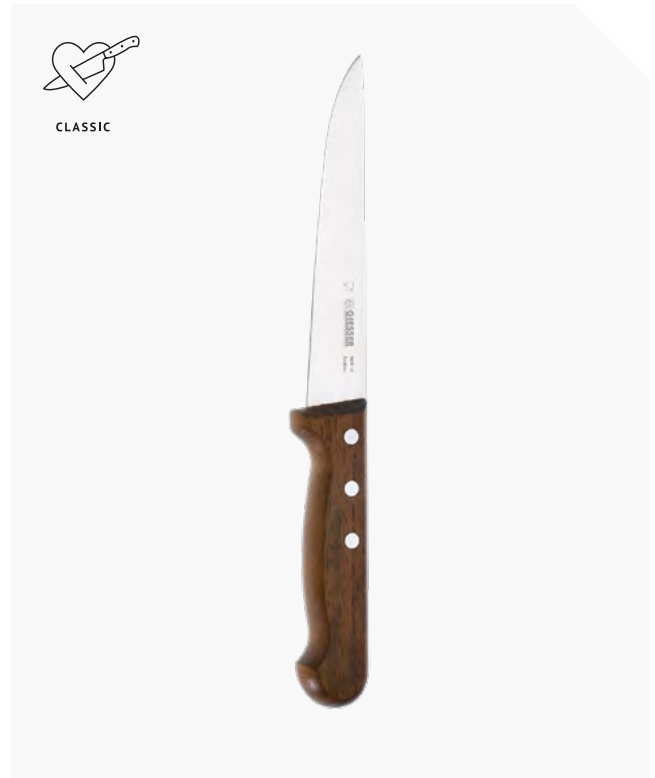

**3000 FSC**  
Sticking knife | single box  
6 1/4 inch 7 inch



**3000**  
Sticking knife  
5 inch 6 1/4 inch 7 inch



**3000 n**  
Knife for various industrial purposes  
5 inch 6 inch



**3080**  
Sticking knife  
6 inch



**3100**  
Boning knife  
5 inch      6¼ inch

**3100 FSC**  
Boning knife | single box  
5 inch



**3110**  
Boning knife | black wooden handle  
6 inch  
•



**4020**  
Butcher knife  
8¼ inch      9½ inch

**4020 FSC**  
Butcher knife | single box  
8¼ inch      9½ inch



**8710**  
Universal knife  
4 inch

**8710 FSC**  
Universal knife | single box  
4 inch



**8300**  
Vegetable knife  
3¼ inch

**8300 FSC**  
Vegetable knife | single box  
3¼ inch



**8340**  
Kitchen knife  
6¼ inch

**8340 FSC**  
Kitchen knife | single box  
6¼ inch



**8360 w**  
Universal knife | wavy edge  
4¼ inch

**8360 w FSC**  
Universal knife | wavy edge,  
single box  
4¼ inch



**8730**  
Steak knife  
4¼ inch





**8750 z**  
Steak knife | serrated edge, palisander wood handle  
4 3/4 inch



**8330**  
Kitchen knife  
5 inch      6 inch  
●              ●

**8330 FSC**  
Kitchen knife | single box  
6 inch



**8350 w**  
Bread knife | wavy edge  
8 3/4 inch



**8450**  
Chef's Knife  
7 3/4 inch      10 1/4 inch

**8450 FSC**  
Chef's Knife | single box  
7 3/4 inch      10 1/4 inch



**8261 w**  
Bread knife | wavy edge  
9 3/4 inch  
●

## POM handles

### 1 POM

Polyoxymethylene is a dimensionally stable and rigid plastic that naturally meets the requirements of the Federal Food and Commodities Regulation.

### 2 ERGONOMICS

The double- or triplervivetted outer or solid material handle provides a safe grip when working in a professional kitchen.



#### 8310 p

Vegetable knife | POM handle

3¾ inch



#### 8360 wp

Universal knife | wavy edge, POM handle

4¾ inch



#### 8330 p

Kitchen knife | POM handle

5 inch



#### 8340 p

Kitchen knife | POM handle

12¼ inch



#### 8540 p

Bird's beak peeling knife | POM handle

2¾ inch



#### 3100 p

Boning knife | POM handle

5 inch





**7300 p**  
Ham slicer | POM handle  
9 3/4 inch  
●



**7700 wp**  
Slicer | wavy edge, highly flexible, POM handle  
11 inch  
●



**8262 p**  
Salmon knife | POM handle  
12 1/4 inch  
●



**8350 wp**  
Bread knife | wavy edge, POM handle  
7 inch      8 1/4 inch  
●              ●



**8261 wp**  
Bread knife | wavy edge, POM handle  
9 3/4 inch  
●



**8350 wp**  
Bread knife | wavy edge, POM handle  
9 1/2 inch  
●



**8450 p**  
Chef's knife | POM handle  
7 3/4 inch      22 1/4 inch  
●              ●



**8451 p**  
Chef's knife | POM handle  
7 3/4 inch  
●

# PrimeLine

PrimeLine features are inspired by nature, making this knife series particularly ergonomic, hygienic, sharp and slip-resistant. Various blade shapes and lengths, flexible or stiff blades, as well as the option of a shorter or longer handle guard make PrimeLine the perfect choice for all areas of food service, meat processing and food processing.

## 1 SERIALY NUMBERED

Practical for allocation and tracking purposes.

## 2 ERGONOMICS

Perfectly balanced knife ensures continuous and efficient cutting with an excellently shaped and rounded handle.

## 3 HANDLE

Smooth and non-slip surface with hard core to ensure complete stability, including short handle guard.





**218455**

Chef's knife | wide

7 1/4 inch      9 inch      10 1/4 inch



**218456**

Chef's knife | narrow

6 1/4 inch      7 inch



**218269 wwl**

Santoku knife | scalloped edge

7 inch



**218335**

Kitchen knife | medium tipped

5 inch



**218269 sp**

Santoku knife „Mano“

7 1/2 inch



**218365 w**

Universal knife | wavy edge

4 1/4 inch



**217365**

Filleting knife

6 1/4 inch      7 inch



**218315**

Vegetable knife | medium tipped

3 1/4 inch      4 inch





**217705 w10**

Slicer | 10 mm wavy edge

8 3/4 inch



**218265 w10**

Universal knife | 10 mm wavy edge

9 3/4 inch



**218355 w10**

Bread knife | 10 mm wavy edge

8 3/4 inch



9 3/4 inch



**218825**

Deba knife

6 inch



**218815**

Yanagiba

9 1/2 inch



**219437**

Meat Fork

7 inch



**219960**

Sharpening steel | oval

12 3/4 inch



Form



**219965**

Sharpening steel | round

12 3/4 inch



Form





**217705 w**  
 Slicer | wavy edge  
 9 3/4 inch      12 3/4 inch  
 ●                      ●



**218265 w**  
 Universal knife | wavy edge  
 9 3/4 inch  
 ●



**218355 w**  
 Bread knife | wavy edge  
 8 3/4 inch  
 ●



**218545**  
 Bird's beak peeling knife  
 2 3/4 inch  
 ●



**219929 - 31 ng**  
 S 88 | Sharpening steel, oval  
 12 3/4 inch  
 ●

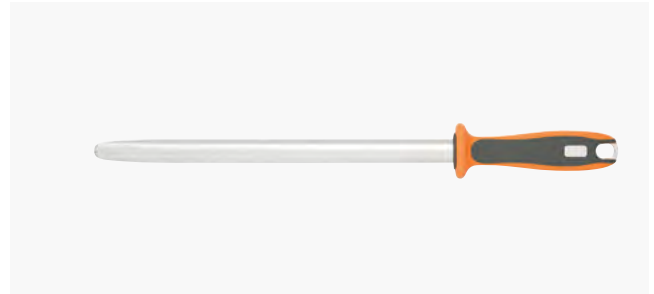

**219933 - 31 no**  
 P 88 | Steel polished  
 12 3/4 inch  
 ●



**229605 ww**  
 Cheese knife | scalloped edge  
 4 3/4 inch  
 ●



**228835**  
 Yanagiba  
 9 1/2 inch  
 ●

# Stamped chef's knives

1 BLADE

2 BACK OF THE BLADE

3 GUARANTEE SEAL

4 EDGE OF KNIFE

5 FINGER/HAND PROTECTION

6 HAND PROTECTION







**8455**

Chef's knife

6 1/4 inch



7 1/4 inch



**8455**

Chef's knife

9 inch



10 1/4 inch



**8455**

Chef's knife

11 1/2 inch



12 1/2 inch



**8445 stpp**

Striking knife

10 1/2 inch



**8456**

Chef's knife | narrow

6 1/4 inch



7 inch



**8456**

Chef's knife | narrow

7 1/4 inch



9 inch



**7705**

Slicer

8 1/4 inch



9 1/4 inch



11 inch



12 1/4 inch



**7705**

Slicer

14 1/4 inch







**8265 w**  
Universal knife | wavy edge  
9 3/4 inch  
● ● ● ● ●



**8265 w l**  
Universal knife | wavy edge, for left-handers  
9 3/4 inch  
●



**8335**  
Kitchen knife  
5 inch      6 inch  
●              ●



**8375 w**  
Offset bread knife | wavy edge  
7 inch      9 inch  
●              ●



**8355 w**  
Bread knife | wavy edge  
7 inch      8 1/2 inch      9 1/2 inch  
●              ● ● ● ●      ● ●



**7365**  
Filleting knife  
6 1/4 inch      7 inch      7 3/4 inch      8 3/4 inch  
● ●              ● ● ●              ● ● ● ●              ● ●



**8345**  
Kitchen knife  
6 1/4 inch      7 inch  
●              ●



**8455 w**  
Chef's knife | wavy edge  
12 1/4 inch  
● ● ● ● ● ● ● ●



**8795**  
Spreader

3½ inch      4¾ inch  
●              ●



**8795 w**  
Spreader | wavy edge

3½ inch      4¾ inch  
●              ●



**9435**  
Sausage fork

5 inch      7½ inch  
● ● ● ● ● ○ ●      ●



**9437**  
Meat fork

7 inch      8¾ inch  
● ● ● ● ●      ●



**8365 wsp**  
Universal Knife | wavy edge

4¾ inch  
● ● ● ● ● ○ ●



**8365 sp**  
Universal Knife

4¾ inch  
● ●



**8365 wsp**  
Universal Knife | wavy edge, in 5 colours  
(light blue, lime, orange, pink, purple)

4¾ inch | ● ● ● ● ●



**8305 sp**  
Vegetable knife  
3 ¼ inch  
● ● ● ● ● ○ ● ● ● ●



**8305 wsp**  
Vegetable knife | wavy edge  
3 ¼ inch  
● ●



**8315 sp**  
Vegetable knife  
3 ¼ inch      4 inch      4 ¼ inch  
● ● ● ● ● ○ ● ● ● ●      ●



**8315 sp**  
Vegetable knife | in 5 colours  
(light blue, lime, orange, pink, purple)  
4 inch | ● ● ● ● ●



**8545 sp**  
Bird's beak peeling knife  
2 ¼ inch      3 inch  
● ● ● ● ● ○ ● ●      ●



**8545 sp**  
Bird's beak peeling knife | in 5 colours  
(light blue, lime, orange, pink, purple)  
2 ¼ inch | ● ● ● ● ●



**8315 wsp**  
Vegetable knife | wavy edge  
3 ¼ inch      4 inch  
●      ● ● ●



**8366 wsp**  
Tomato knife | with tines  
4 ¼ inch  
● ●



**8725 sp**  
 Steak knife  
 4 1/4 inch  
 ● ●



**8725 wsp**  
 Steak knife | wavy edge  
 4 1/4 inch  
 ● ●



**8309 sp 8-5**  
 Roll knife set | 5 pcs.  
 3 1/4 inch  
 ●



**8309 wsp 8-5**  
 Roll knife set | 5 pcs., wavy edge  
 3 1/4 inch  
 ●



**9466 sp**  
Spoon



**9467 sp**  
Tea Spoon



**9465 sp**  
Fork



**9468 sp**  
Pastry fork



**8365 wsp 11-6**  
Universal knife set | 6 pcs.



**9465 sp-6**  
Fork set | 6 pcs.



**8455**  
 Chef's knife  
 7 3/4 inch



**8456**  
 Chef's knife | narrow  
 6 1/4 inch



**8265 w**  
 Universal knife | wavy edge  
 9 3/4 inch



**3585**  
 Vegetable knife set | 4 pcs.  
 Contents: 8305 sp-8, 8315 sp-10, 8545 sp-6, 8365 wsp-11



**9850**  
 Cook's knife set | 3 pcs.  
 Contents: 8269 wwlk-18, b8456-18, 8315 sp-10







**9851**

Cook's knife set | 3 pcs.

Contents: b8456-18, 8315 sp-10, 8365 wsp-11



**9852**

Cook's knife set | 3 pcs.

Contents: 8269 wwlk-18, 8315 sp-10, 8365 wsp-11



**9879 sp 24**

Cutlery set | 24, pcs.



**9872 spvk**

Sales carton | 72 pcs., 6 different colours  
(8365 wsp-11 in black, yellow, red, blue, white, green)

**9872 spvk 9x8**

Sales carton | 72 pcs., 9 different colours  
(8365 wsp-11 in black, yellow, red, green, light blue, lime, orange, pink, purple)

**69505**

Sales display | turnable, empty  
Dimensions (without hooks): 20 x 9 x 9 inch

**9872 kt**

Sales carton | 60 universal knives in 6 different colours  
(8365 wsp-11 in blue, green, lime, orange, pink, purple)

## Light purple

Where food is being prepared, particular attention needs to be paid to safety and hygiene. The HACCP range was extended by adding a knife with special light violet handles for preparing vegan, allergen free and halal dishes, thereby responding to current developments in the food industry.

### 1 SAFETY

Colours support and complement your hygiene concept in food processing. Ideal für die vegane, allergenfreie und Halal-Gastronomie

### 2 MATERIAL

Polypropylene without any additives that could be derived from tallow/lard.





**3165 pp hvi**

Boning knife | light purple

6 inch



**4025 pp hvi**

Butcher knife | light purple

8 1/4 inch



**6005 pp hvi**

Steak knife | light purple

10 1/2 inch



**7705 wpp hvi**

Slicer | wavy egde, light purple

12 1/4 inch



**8315 sp hvi**

Vegetable knife | light purple

4 inch



**8455 pp hvi**

Chef's knife | light purple

7 3/4 inch

10 1/4 inch



**8456 pp hvi**

Chef's knife | light purple

6 1/4 inch







**8165 z**  
Pie knife | serrated edge  
6 1/4 inch

●



**8205**  
Confectioner's spatula  
4 inch

●



**8215**  
Spatula  
6 1/4 inch

● ● ○



**8215**  
Spatula  
8 1/4 inch    10 1/4 inch    12 1/4 inch    14 1/4 inch

● ○

● ○

● ○

● ○



**8235**  
Offset spatula | mini

●



**8235**  
Offset spatula  
6 1/4 / 4 inch    8 1/4 / 6 inch    10 1/4 / 7 1/4 inch    12 1/4 / 9 1/4 inch

●

● ○

● ○

●



**8232**  
Pan flipper  
6 1/2 / 4 1/2 inch    9 3/4 / 7 1/2 inch

●

● ○



**8232 p**  
Pan flipper | POM handle  
4 1/2 inch

●



**8232 f**  
Pan flipper | flexible  
4½ inch  
•



**8225**  
Scraper  
4 inch  
•



**8233**  
Burger spatula | extra broad  
5½ x 5½ inch  
•



**8234**  
Offset spatula  
6¼/4¼ inch  
•



**8234 p**  
Offset spatula | POM handle  
6¼/4¼ inch  
•



**8237**  
Turner  
6¼ inch  
•



**8239**  
Turner | wide  
6¼/4¼ inch  
•



**8239 s**  
Offset spatula  
5½ inch  
●



**9575**  
Thermo offset spatula | flexible  
●



**8355 w**  
Bread knife | wavy edge  
7 inch      8¼ inch      9½ inch  
●              ● ● ● ○              ● ○



**218265 w**  
Universal knife | wavy edge  
9¾ inch  
●



**218355 w10**  
Bread knife | 10 mm wavy edge  
8¼ inch      9½ inch  
●              ●



**8307 wsp**  
Roll knife | wavy edge  
3¼ inch  
● ●



**8355**  
Bread knife  
8¼ inch  
●



**8355 wsp**  
Bread knife | wavy edge  
7½ inch  
●





**8375 w**

Bread knife | wavy edge, offset

7 inch      9 inch



**8395 w**

Bread knife with distance device | wavy edge

8 1/4 inch      9 1/2 inch



**8396**

Bread knife with distance device

9 3/4 inch



**8396 w**

Bread knife with distance device | wavy edge

9 3/4 inch



# Cheese knives

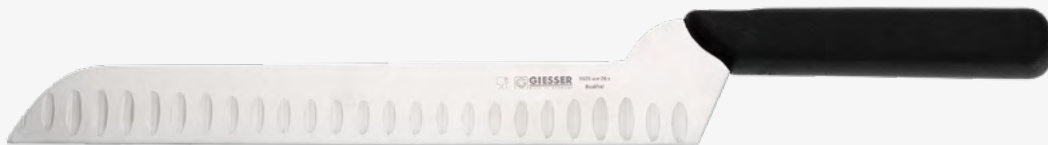

**9605**  
Cheese knife

10¼ inch    11½ inch



**9605 ww**  
Cheese knife | scalloped edge

7¾ inch    10¼ inch    11½ inch



**9615**  
Cheese knife

10¼ inch    11½ inch



**9615**  
Cheese knife

14¼ inch



**9615 ww**  
Cheese knife | scalloped edge

10¼ inch    11½ inch



**9620**  
Cheese shovel

6 inch    7¾ inch



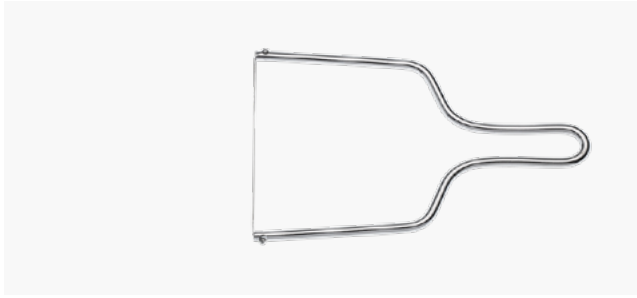

**9630**  
Wire cheese cutter  
4 3/4 inch      9 inch



**9570**  
Spatula  
10 1/4 inch  
● ○

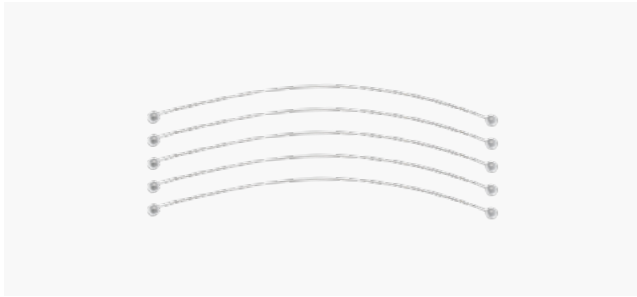

**9631**  
Spare loops | 5 pcs.  
4 3/4 inch      9 inch



**9645**  
Soft cheese knife  
6 inch  
● ● ● ○



**9655**  
Cream cheese knife  
6 inch  
● ● ○



**9655 sp**  
Cream cheese knife  
6 inch  
● ● ● ○



**9492**  
Cheese slicer  
13 inch  
●



**9493**  
Cheese wire  
48 inch

**9493 dr**  
Spare loops | 10pcs.



**9495**  
Parmesan knife  
4 1/4 inch  
•



**9495**  
Parmesan knife  
6 1/4 inch  
•



**9495 rs**  
Parmesan crust knife  
•

# Fish knives



**8455**

Chef's knife

6 1/4 inch



7 3/4 inch



9 inch



**8455**

Chef's knife

10 1/4 inch



11 1/2 inch



12 1/4 inch



**8455 w**

Chef's knife | wavy edge

12 1/4 inch



**8280 w**

Chef's knife | wavy edge, wide

9 3/4 inch



**8280**

Chef's knife | wide

6 inch



7 inch



7 3/4 inch



**8280**

Chef's knife | wide

9 inch



9 3/4 inch



11 1/4 inch





**2285**  
Filleting knife

7 inch      8 ¼ inch  
● ●      ● ●



**2275**  
Filleting knife

7 inch      8 ¼ inch  
● ●      ● ● ●



**2105**  
Skinning knife

5 inch      6 ¼ inch      7 inch      8 ¼ inch  
● ●      ● ●      ● ● ● ● ●      ● ● ●



**6005**  
Steak knife

8 ¼ inch      9 ½ inch      10 ½ inch      11 ¼ inch  
● ● ● ● ●      ● ● ● ● ●      ● ● ● ● ●      ● ● ● ● ●



**7365**  
Filleting knife

6 ¼ inch      7 inch      7 ¾ inch      8 ¼ inch  
● ●      ● ● ●      ● ● ●      ● ●



**8264**  
Filleting knife

7 inch  
● ● ● ● ●



**8270**  
Chef's knife | narrow

6 inch      7 inch      7 ¾ inch  
●      ● ● ● ● ●      ● ● ● ● ●



**8270**  
Chef's knife | narrow

9 inch      9 ¾ inch  
● ● ● ● ●      ●



**3055**  
Cod knife  
7 inch  
●



**3055 f**  
Cod filleting knife  
7 inch  
● ●



**4025 wwl**  
Butcher knife | scalloped edge  
8 1/4 inch ●    9 1/2 inch ● ● ● ●    10 1/2 inch ●



**8475 wwl**  
Salmon knife | scalloped edge  
12 1/4 inch ● ●



**8315 wsp**  
Vegetable knife | wavy edge  
3 1/4 inch ●    4 inch ● ● ●



**9501 4**  
Fish spatula  
8 x 3 inch  
●



**8335 s**  
Fish knife | strong blade  
5 inch  
●



**9516**  
Fish pincers



**9514 ang**  
Pincers | angled  
6 inch      13 3/4 inch



**9515**  
Fish bone pliers



**9551**  
Lobster pliers



**9550**  
Lobster fork

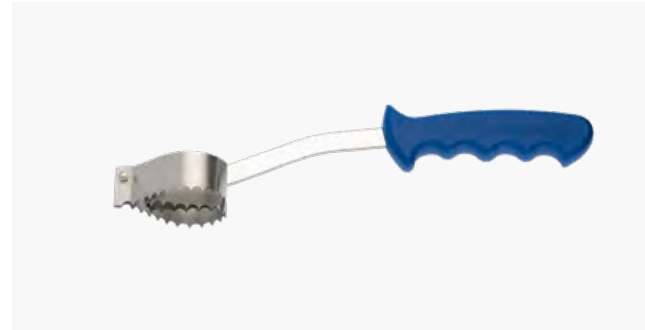

**9518**  
Fish descaler



**8247**  
Oyster knife



**8247 07**  
Oyster knife





**3235 z**  
Fish descaling knife  
6 inch  
●



**12250**  
Boning knife | flexible  
5 inch      6 inch  
● ● ● ●      ● ● ● ●



**9505**  
Fish fin shears



**9505 k**  
Fish fin shears  
●



**9505 sp**  
Fish fin shears  
●



**9590 mf**  
Mesh safety glove | mitt, one size fits all

## PremiumCut

Arresting design, unbelievable sharpness and perfect workmanship combine to make this new knife series something very special. A first glance is all it takes for sparks to fly – you'll be fascinated by these tools in no time.

High-quality chrome-molybdenum steel, tempered to a full 57 HRC, then finely polished and finally sharpened by a master craftsman, guarantees long-lasting enjoyment.

To complement the ten different blades, we offer a choice of four different handles made from carefully selected materials. Together with our extraordinary blades, they make for particularly valuable masterpieces.



High-quality blades are just the beginning: Now, we turn our full attention to extraordinary handle variants. Carefully selected materials, such as White Cedar or Micarta, complement the perfect quality of the blades – making GIESSER knives true masterpieces.

#### THUJA – TREE OF LIFE

Tradition meets perfection. White cedar burl wood makes our Tree of Life handle a cut above. White cedar – also known as arborvitae or “tree of life” – has an extremely tough burl that makes using the knife an absolute pleasure. A handle of exceptional quality.



#### RED DIAMOND

The impressive design gets our hearts pumping. Red Diamond takes your breath away: the special manufacturing process creates one-of-a-kind plastic handles, each one unique. Fire, meat and Red Diamond – what could be better?

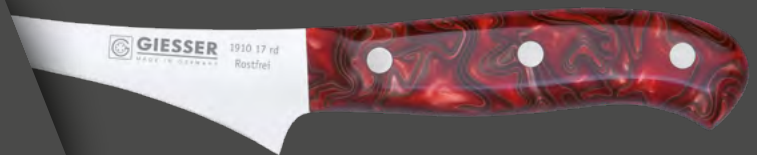

#### SPICY ORANGE

One look is enough to heighten all your senses and get ready for cooking. Exotic fragrances and spices mingle – you are one with your knife.



#### ROCKING CHEFS

Rocking Chefs are tough guys with a soft core: Micarta, a natural material. No handle is like another, making you a true hero of the kitchen. “Rocking Chef” Ralf Jakumeit would go through fire for his absolute favourite!





**1900 20 rd**  
Chefs No 1 | Red Diamond  
7 1/4 inch



**1900 20 rc**  
Chefs No 1 | Rocking Chef  
7 1/4 inch



**1900 20 so**  
Chefs No 1 | Spicy Orange  
7 1/4 inch



**1900 20 tol**  
Chefs No 1 | Tree of life  
7 1/4 inch



**1900 30 rd**  
Barbeque No 1 | Red Diamond  
11 1/4 inch



**1900 30 rc**  
Barbeque No 1 | Rocking Chef  
11 1/4 inch



**1900 30 so**  
Barbeque No 1 | Spicy Orange  
11 1/4 inch



**1900 30 tol**  
Barbeque No 1 | Tree of life  
11 1/4 inch



**1910 17 rd**  
Filet No 1 | Red Diamond  
6 3/4 inch



**1910 17 rc**  
Filet No 1 | Rocking Chef  
6 3/4 inch



**1910 17 so**  
Filet No 1 | Spicy Orange  
6 3/4 inch



**1910 17 tol**  
Filet No 1 | Tree of life  
6 3/4 inch



**1920 10 rd**  
Office No 1 | Red Diamond  
4 inch



**1920 10 rc**  
Office No 1 | Rocking Chef  
4 inch



**1920 10 so**  
Office No 1 | Soicy Orange  
4 inch



**1920 10 tol**  
Office No 1 | Tree of life  
4 inch



**1930 w 25 rd**  
Wave No 1 | Red Diamond  
9 3/4 inch



**1930 w 25 rc**  
Wave No 1 | Rocking Chef  
9 3/4 inch



**1930 w 25 so**  
Wave No 1 | Spicy Orange  
9 3/4 inch



**1930 w 25 tol**  
Wave No 1 | Tree of life  
9 3/4 inch

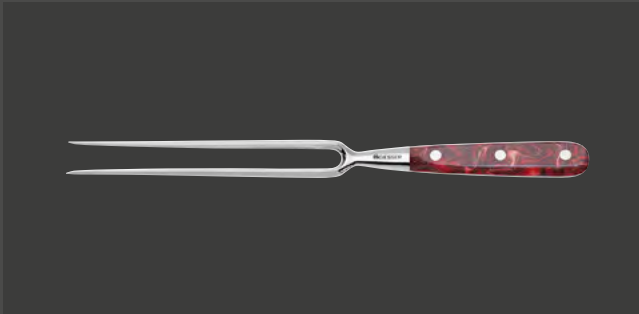

**1940 21 rd**  
Fork No 1 | Red Diamond  
8 3/4 inch

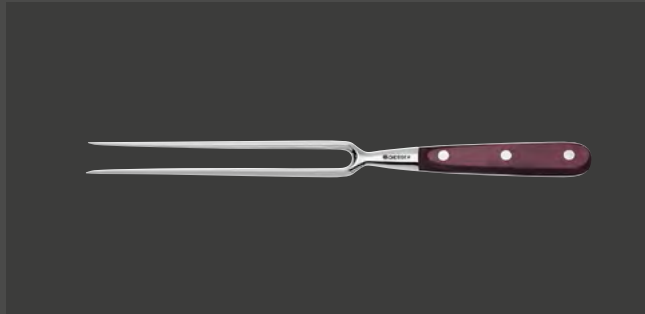

**1940 21 rc**  
Fork No 1 | Rocking Chef  
8 3/4 inch



**1940 21 so**  
Fork No 1 | Spicy Orange  
8 3/4 inch



**1940 21 tol**  
Fork No 1 | Tree of life  
8 3/4 inch



**1950 12 rd**  
Steak No 1 | Red Diamond  
4 3/4 inch



**1950 12 rc**  
Steak No 1 | Rocking Chef  
4 3/4 inch



**1950 12 so**  
Steak No 1 | Spicy Orange  
4 3/4 inch



**1950 12 tol**  
Steak No 1 | Tree of life  
4 3/4 inch

**1950 - 12 o**

Steak No 1 | Olivenholz

4 3/4 inch

**1950 - 12-4 o**

Steak No 1 | Olivenholz 4er Set

4 3/4 inch

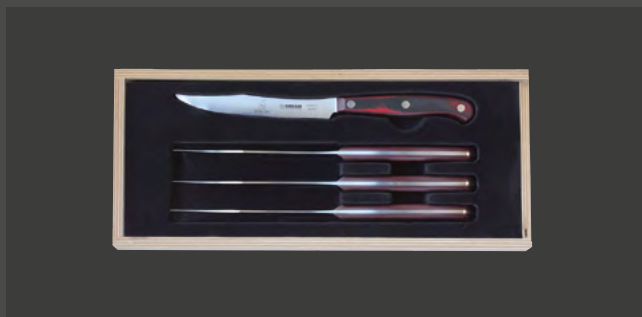
**1950 - 12-4 rc**

Steak No 1 | Rocking Chef 4er Set | Auch einzeln erhältlich

4 3/4 inch

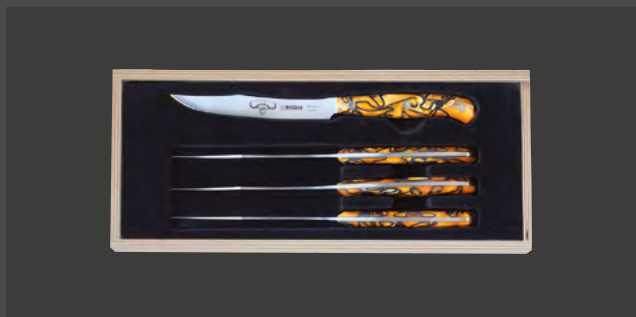
**1950 - 12-4 so**

Steak No 1 | Spicy Orange 4er Set | Auch einzeln erhältlich

4 3/4 inch

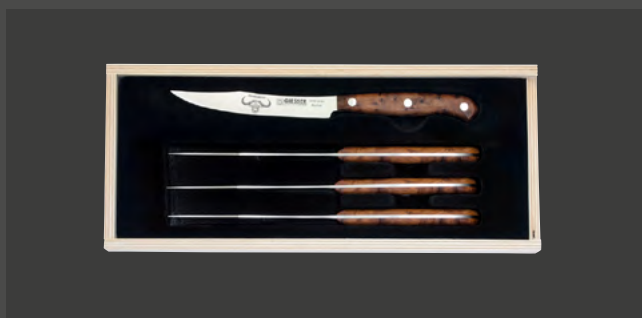
**1950 - 12-4 tol**

Steak No 1 | Tree of life 4er Set | Auch einzeln erhältlich

4 3/4 inch

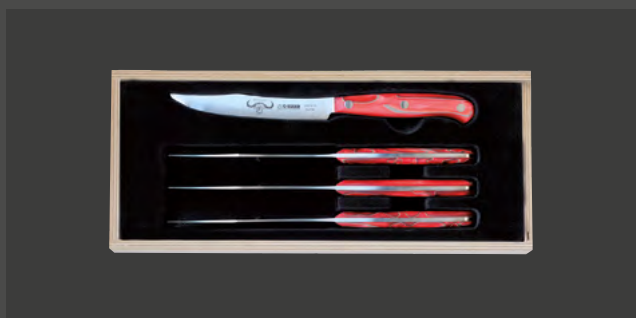
**1950 - 12-4 rd**

Steak No 1 | Red Diamond 4er Set | Auch einzeln erhältlich

4 3/4 inch





**1955 - 31 rc**  
Slicer No. 1 | Rocking Chef  
12 1/4 inch



**1955 - 31 rd**  
Slicer No. 1 | Red Diamond  
12 1/4 inch



**1955 - 31 so**  
Slicer No. 1 | Spicy Orange  
12 1/4 inch



**1955 - 31 tol**  
Slicer No. 1 | Tree of Life  
12 1/4 inch



**1960 - 25 rc**  
Steel No. 1 | Rocking Chef  
9 3/4 inch



**1960 - 25 rd**  
Steel No. 1 | Red Diamond  
9 3/4 inch



**1960 - 25 so**  
Steel No. 1 | Spicy Orange  
9 3/4 inch



**1960 - 25 tol**  
Steel No. 1 | Tree of Life  
9 3/4 inch



**1965 - 22 rc**  
Butcher No. 1 | Rocking Chef  
8 3/4 inch



**1965 - 22 rd**  
Butcher No. 1 | Red Diamond  
8 3/4 inch



**1965 - 22 so**  
Butcher No. 1 | Spicy Orange  
8 3/4 inch



**1965 - 22 tol**  
Butcher No. 1 | Tree of Life  
8 3/4 inch

**1988 2 rd**

PremiumCut Set Nr. II | Red Diamond

Contents: 1900 20 rd, 1920 10 rd

**1988 2 rc**

PremiumCut Set Nr. II | Rocking Chef

Contents: 1900 20 rc, 1920 10 rc

**1988 2 so**

PremiumCut Set Nr. II | Spicy Orange

Contents: 1900 20 so, 1920 10 so

**1988 2 tol**

PremiumCut Set Nr. II | Tree of life

Contents: 1900 20 tol, 1920 10 tol

**1996 3 rd**

PremiumCut Set Nr. III | Red Diamond

Contents: 1930 w 25 rd, 1900 20 rd, 1920 10 rd

**1996 3 rc**

PremiumCut Set Nr. III | Rocking Chef

Contents: 1930 w 25 rc, 1900 20 rc, 1920 10 rc

**1996 3 so**

PremiumCut Set Nr. III | Spicy Orange

Contents: 1930 w 25 so, 1900 20 so, 1920 10 so

**1996 3 tol**

PremiumCut Set Nr. III | Tree of life

Contents: 1930 w 25 tol, 1900 20 tol, 1920 10 tol

**1997 2 rd**

PremiumCut Tranchierset | Red Diamond

Contents: 1900 20 rd, 1940 21 rd

**1997 2 rc**

PremiumCut Tranchierset | Rocking Chef

Contents: 1900 20 rc, 1940 21 rc

**1997 2 so**

PremiumCut Tranchierset | Spicy Orange

Contents: 1900 20 so, 1940 21 so

**1997 2 tol**

PremiumCut Tranchierset | Tree of life

Contents: 1900 20 tol, 1940 21 tol



**1999 3 rd**

3er Set | Red Diamond

Contents: 1900 30 rd, 1900 20 rd, 1910 17 rd

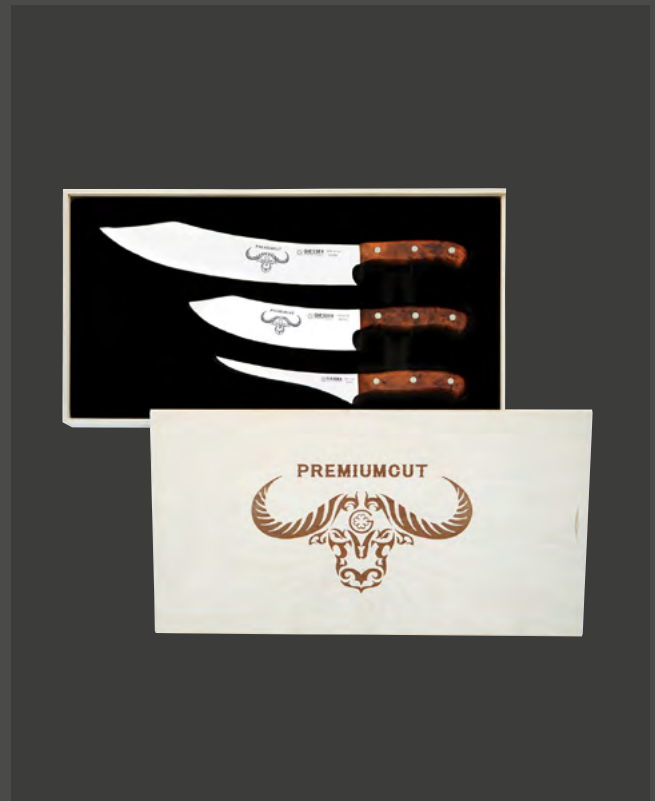

**1999 3 tol**

3er Set | Tree of life

Contents: 1900 30 tol, 1900 20 tol, 1910 17 tol



**1999 3 so**

3er Set | Spicy Orange

Contents: 1900 30 so, 1900 20 so, 1910 17 so



**1999 3 rc**

3er Set | Rocking Chef

Contents: 1900 30 rc, 1900 20 rc, 1910 17 rc

## Steak cutlery



**9450**

Steak fork | palisander handle



**8750 z**

Steak knife | serrated edge, palisander wood handle  
4 3/4 inch



**9450 o**

Steak fork | olive wood handle



**8750 z o**

Steak knife | serrated edge, olive wood handle  
4 3/4 inch



**9450 p**

Steak fork | POM handle



**8750 pz**

Steak knife | serrated edge, POM handle  
4 3/4 inch



**9750**

Steak cutlery, 4 pcs.,  
in aluminium box,  
palisander

**9750 p**

Steak cutlery, 4 pcs.,  
in aluminium box,  
POM

**9750 o**

Steak cutlery, 4 pcs.,  
in aluminium box,  
olive wood



**9750-2**

Steak cutlery, 2 pcs.,  
palisander wood  
handle

**9750-2 p**

Steak cutlery, 2pcs.,  
POM handle

**9750-2 o**

Steak cutlery, 2 pcs.,  
olive wood handle



**8242**

Steak knife

4 3/4 inch



**8730**

Steak knife

4 3/4 inch



**8725 sp**

Steak knife

4 3/4 inch



**8725 wsp**

Steak knife | wavy edge

4 3/4 inch







# Accessories

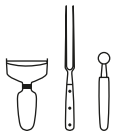

## ACCESSORIES

The right tool for any occasion.

130 – 146

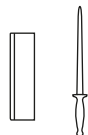

## SHARPENING

Professional sharpeners and butcher tools.

147 – 153

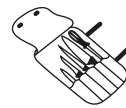

## STORAGE

Knife bags and cases.

154 – 159

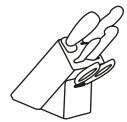

## KNIFE BLOCKS

Knife block made from beechwood.

160 – 161



## PROTECTION

Cut protection gloves, stab protection aprons and boleros.

162 – 166

## Accessories



### 9605 bs

Decorating knife | easy cutting with angled blade, extra long  
4 ¾ inch

•

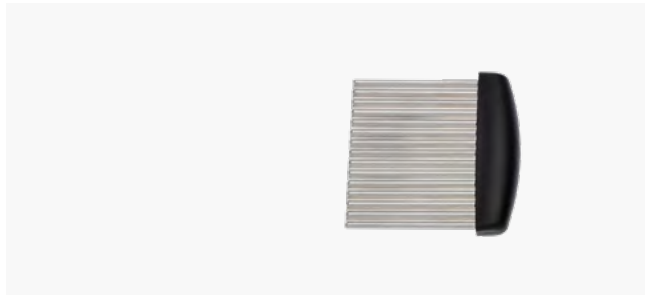

### 8250 9x7

Decorating knife

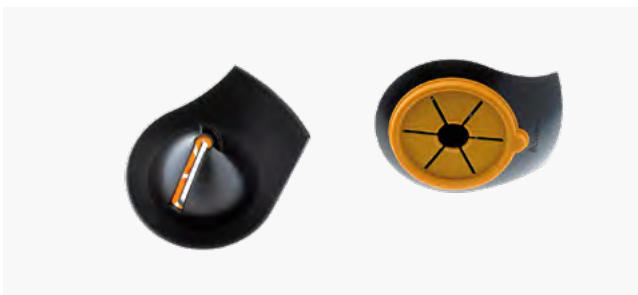

### 9476 3

Endless spiral cutter

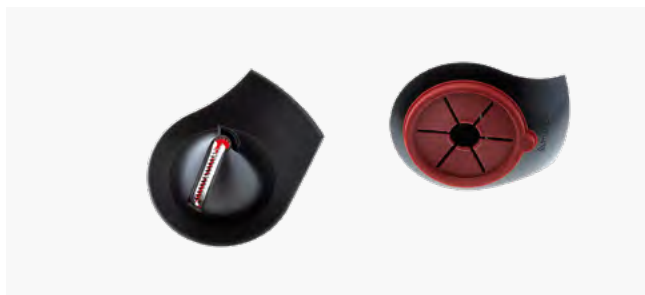

### 9476 2

Endless julienne cutter



**9475**  
Julienne cutter | 3 mm

- 



**9475 3**  
Julienne cutter | with 3 blades (3, 6, 9 mm)

- 



**9470**  
Tomato peeler

- 



**8246**  
Asparagus peeling knife

- 



**8249 rap**  
Peeler

- 
- 
- 
- 
- 
- 



**8249**  
Peeler

- 



**8249 sp**  
Peeler

- 

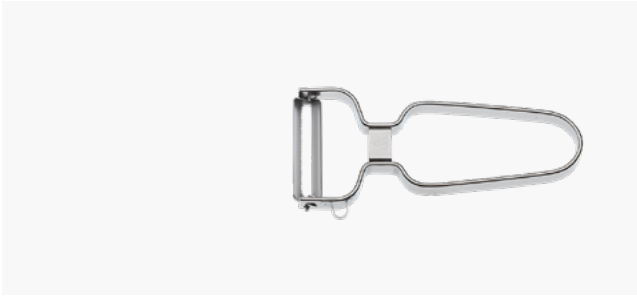

**8249 m**  
Peeler | metal, plane edge  
2 inch      3½ inch

**8249 mz**

Peeler | metal, serrated edge

2 inch

**8254**

Orange peeler

•

**8255**

Lemon decorator

•

**8256**

Lemon grater

•

**8256 sp re**

Decorating knife

•

**8256 lo**

Lemon grater

•

**8257**

Butter curler

•

**8259**

Apple corer

•



**8252**  
 Double melon baller  
 ø 0.9/1.0 inch  
 •



**8253**  
 Melon baller  
 ø 0.4 inch    ø 0.5 inch    ø 0.7 inch    ø 0.9 inch  
 •                    •                    •                    •



**8253**  
 Melon baller  
 ø 1.0 inch    ø 1.2 inch  
 •                    •



**8253 o**  
 Melon baller | oval  
 •



**8253 ow**  
 Melon baller | oval, wavy  
 •



**9471**  
 Tomato corer  
 •



**9480 sp**  
 Grapefruit knife  
 •

**9487**

Pastry brush

1½ inch      2¼ inch

**9487 sil**

Pastry brush | silicon

•

**9482**

Pastry wheel

ø 2¼ inch

•

**9482 w**

Pastry wheel | wavy

ø 2¼ inch

•

**9491**

Pizza cutter

ø 4¼ inch

•

**8287**

Mincing knife | double

8¾ inch

•

**8288**

Mincing knife | single

6 inch      8¾ inch

•

•

**8288**

Mincing knife | single

14¼ inch

•



**6810 b**  
Decorating set  
Contents: 8252, 8254, 8256,  
8257, 8259, 8255, 8249

**6810 l**  
Decorating set bag  
Without contents

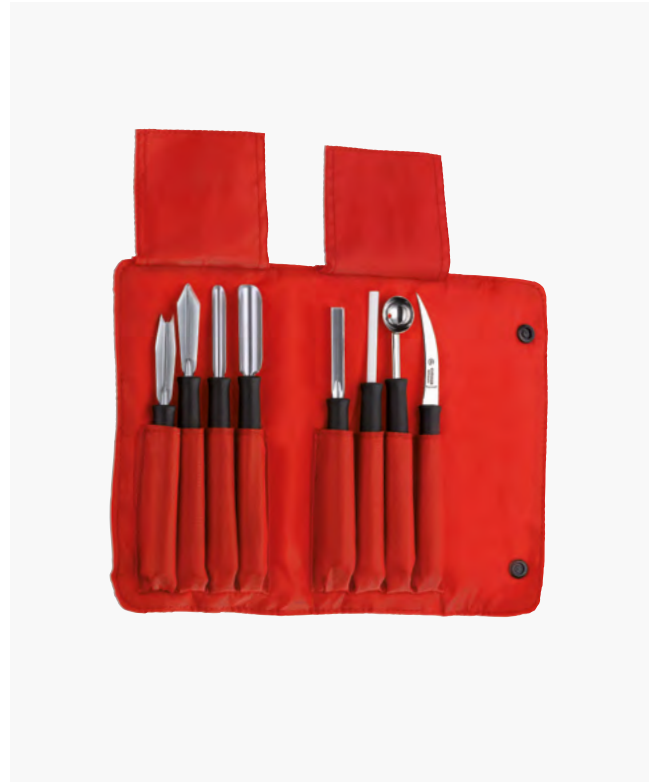

**9478**  
Fruit carving set | 8 pcs.  
•



**9510**  
Truffle slicer

**9478 5**

Shaping knife | narrow

2 inch

**9540**

Cake tongs

**9542**

Salad tongs

**9545**

Spaghetti tongs

**9514**

Pincers

7 1/4 inch

11 1/4 inch

**9514 ang**

Pincers | angled

6 inch

**9516 ang**

Pincers | angled

7 1/4 inch

**9514 ang**

Pincers | angled

13 1/4 inch





**9535**  
Cold cut tongs



**9514 k**  
Meat pincers | heat resistant up to 240 °C  
11 $\frac{1}{4}$  inch



**9501**  
Can opener



**9483**  
Rubber spatula  
10 $\frac{3}{4}$  inch



**9488**  
Dough scraper set | 3 pcs.  
2 x 4 $\frac{1}{2}$  inch    1 x 4 $\frac{3}{4}$  inch



**9489 2**  
Dough scraper set | 2 pcs.  
6 & 7 $\frac{3}{4}$  inch



**9570**  
Spatula  
10 $\frac{1}{4}$  inch  
● ○

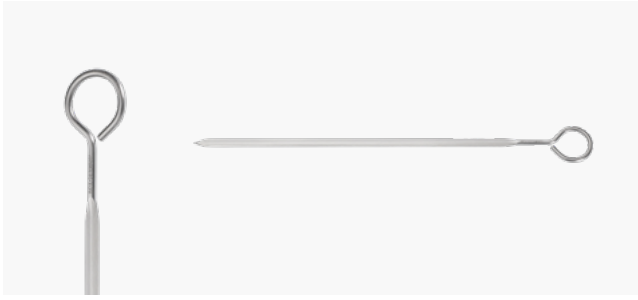

**9575**  
Thermo offset spatula | flexible, heat resistant up to 240 °C  
12 $\frac{1}{4}$  inch  
●

**9500**

Skewer

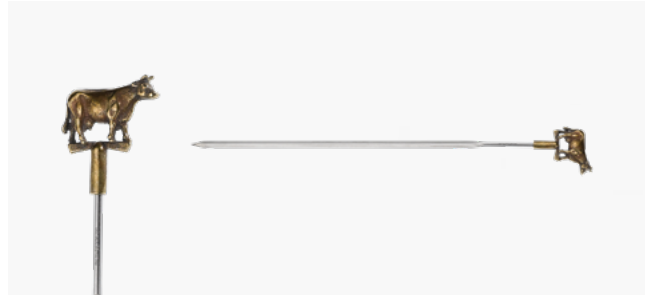
7 $\frac{1}{4}$  inch9 $\frac{1}{4}$  inch11 $\frac{1}{4}$  inch**9500 co**

Skewer | cow

11 $\frac{1}{4}$  inch**9500 au**

Skewer | fowl

11 $\frac{1}{4}$  inch**9500 cr**

Skewer | cross

11 $\frac{1}{4}$  inch**9500 fi**

Skewer | fish

11 $\frac{1}{4}$  inch**9500 la**

Skewer | lamb

11 $\frac{1}{4}$  inch**9500 li**

Skewer | fleur de lys

11 $\frac{1}{4}$  inch**9500 ro**

Skewer | rooster

11 $\frac{1}{4}$  inch



**9400 p**

Meat fork | forged

6 inch      7¼ inch  
●            ●



**9410 p**

Claw fork | forged

6 inch      7 inch      8¼ inch      9¼ inch  
●            ● ● ● ● ●      ●            ●



**9420 p**

Sausage fork | forged

5 inch  
●



**9435**

Sausage fork

5 inch      7½ inch  
● ● ● ● ●      ●



**9437**

Meat fork

7 inch      8¼ inch  
● ● ● ● ●      ●



**9445**

Meat fork

6 inch  
●



**219437**

Meat Fork

7 inch  
●

**6800**

Magnet bar

13 $\frac{3}{4}$  inch    19 $\frac{3}{4}$  inch**6800 sp**

Magnet bar | special

23 $\frac{1}{2}$  inch**6800 h1**Hook | for magnet bar  
single (2 pcs.)**6800 h2**Hook | for magnet bar  
double (2 pcs.)**8258**

Poultry shears

**8258 f**

Replacing spring

**8258 sp**

Poultry shears

**8258 spf**

Replacing spring

**9501 6**

Kitchen shears

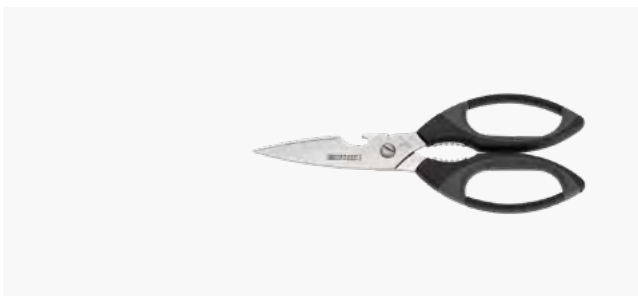
**9506**

Scissors

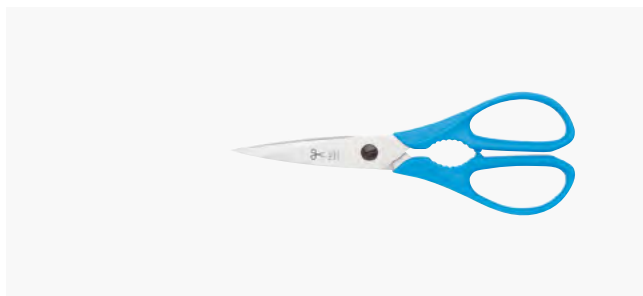
**9506 10**

Scissors

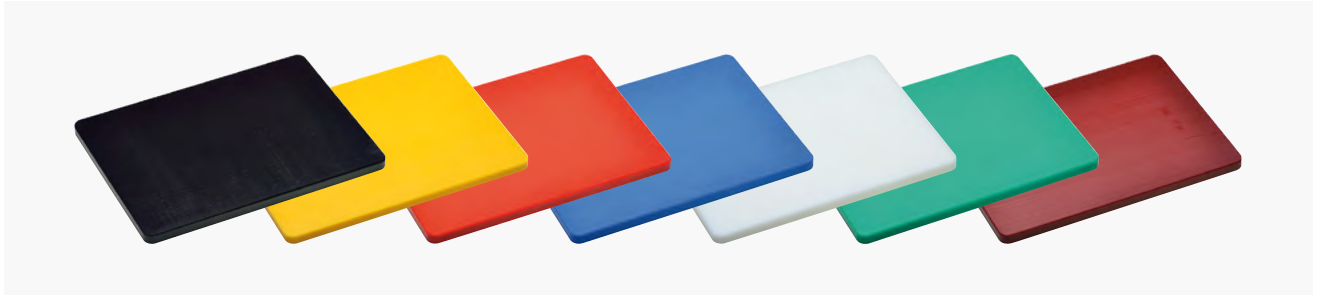

**6865**

Cutting board

40 cm (400 x 300 x 20 mm)



50 cm (500 x 300 x 20 mm)



60 cm (600 x 300 x 20 mm)



**6870**

Euro cutting board | rounded edges, with groove and juice collector

53 cm (530 x 325 x 20 mm)



**6868**

Anti-Slip Pad





**6820 la**  
Gastronorm inset  
19 x 10 $\frac{3}{4}$  inch

**6820 h**  
Mountings, 1 pair



**6880**  
Stirring spatula  
39 $\frac{1}{2}$  inch      48 inch  
○                      ○



**6867**  
Scraper for cutting boards  
○



**6867 kl**  
Spare blade | for scraper 6867



**6845**  
Meat hammer  
○



**6840 p**  
Cutlet pounder



**6605**

Bone saw

15 3/4 inch



19 3/4 inch



**6606 40**

Saw blade

**6606 50**

Saw blade



**6630 k**

Beef splitter

13 inch



**6645**

Cleaver

6 inch (ca. 400 g)



**6640 p**

Cleaver | POM handle

6 inch (ca. 500 g)



**6655**

Cleaver

7 inch (ca. 550 g)



7 3/4 inch (ca. 650 g)



**6655 sp**

Cleaver

7 inch (ca. 910 g)



7 3/4 inch (ca. 1010 g)



**6655 sp**

Cleaver

9 1/4 inch (ca. 1080 g)



10 inch (ca. 1240 g)





**6795**  
Minced meat knife  
5½ inch



**6616**  
Hook  
5½ inch



**6608**  
Bacon ripper  
16 mm



**6609**  
Rib puller  
14 mm

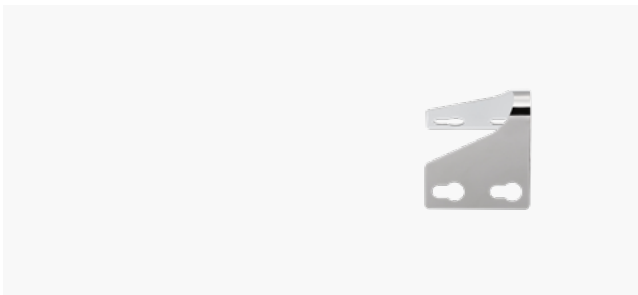

**6615**  
Rib puller spare blades | 5 pcs.

14 mm    16 mm    18 mm    20 mm    22 mm

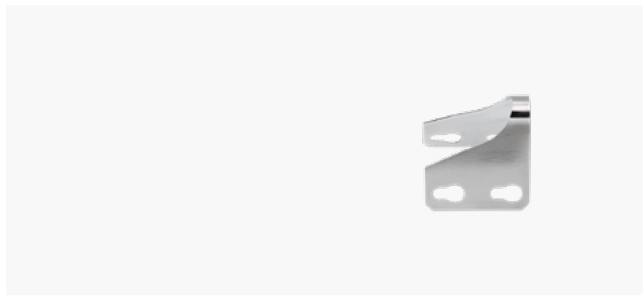

**6615 a**  
Rib puller spare blades | extra sharp, 5 pcs.

14 mm    16 mm

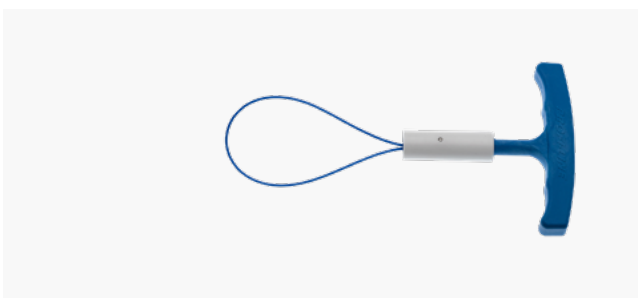

**6610**  
Rib puller  
ø2 mm

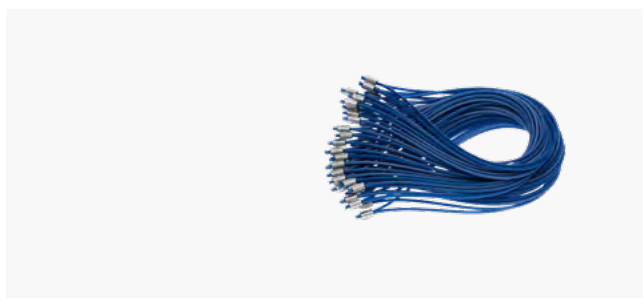

**6611**  
Rib puller spare loops | 50 pcs.  
7¼ inch    11¼ inch





**6850**  
Block brush



**6698**  
Ring knife | plastic, 3 pcs.

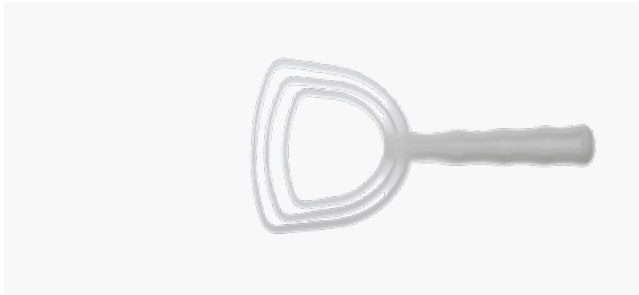

**6612**  
Bone dust remover

• ○

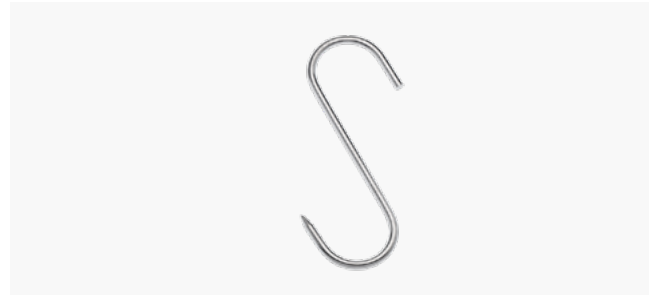

**6860**  
"S" hook | 10 pcs.

4 inch    4 ¼ inch    5 ½ inch    6 ¼ inch    7 inch



**6688**  
Pork scorer

•



**6699**  
PELLE The sausage casing cutter

•

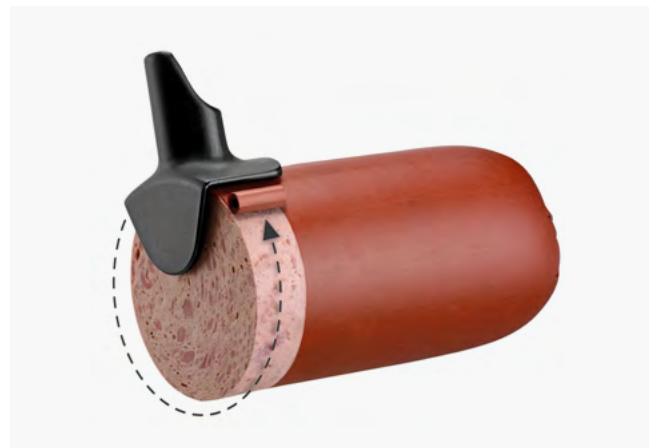



**7990**  
Butcher pocket knife  
4 inch



**7990 3**  
Hunting knife | 57-58 HRC Rockwell, stamped, handle made of genuine mikarta, riveted, with saddle leather bag  
4 1/4 inch



**7984 c**  
Sausage testing knife | with fork and clip, full metal  
4 1/4 inch



**7981 c**  
Sausage testing knife  
4 1/4 inch



**7981 csp**  
Sausage testing knife | with fork and clip  
4 1/4 inch  
● ● ● ○



**7984 c-h**  
Plastic sheet for sausage testing knife

# Professional grinding and butcher supply tools

1 FINE CUT

2 ERGONOMIC HANDLE





**9970 wb**  
Hand sharpening stone | fused alumina, 200 blue/400 white  
20 cm (200 x 50 x 25 mm)



**9970 s**  
Hand sharpening stone | siliciumcarbide, 120/320  
20 cm (200 x 50 x 25 mm)



**9970 wt**  
Hand sharpening stone | fused alumina, extra fine,  
360 terra/ 1000 white  
20 cm (200 x 50 x 25 mm)



**9970 99**  
Mat | black  
•



**9970**  
Hand sharpening stone | coarse/fine, stone length 10 inch,  
total length 15 inch, for knives and tools  
10 inch  
•



**9930**  
Sharpening steel | diamond coated  
9 3/4 inch      Form  
•                      ●



**9940**  
Ceramic sharpening steel  
9 3/4 inch      Form  
•                      ●



**9919**  
Sharpening steel | double cut, extra fine, polished  
9 3/4 inch      Form  
•                      ■



**9901**

Silvercut | polished

12 1/4 inch      Form



**PX 88**

PX 88 | special coating extremely hard,  
2000 Vickers degrees hardness

12 1/4 inch      Form



**9913**

Topcut | ultra fine polished cut

12 1/4 inch      Form



**9916**

Supercut | ultra fine cut

12 1/4 inch      Form



**9906**

Policut | ultra fine cut extra

12 1/4 inch      Form



**9905**

Sharpening steel | extra fine cut

12 1/4 inch      Form



**9904**

Sharpening steel | ultra fine cut

12 1/4 inch      Form



**9920**

Chefcut | fine cut

12 1/4 inch      Form





**9922**  
Chefcut | fine cut

9 3/4 inch      Form  
●                      ●



**9925**  
Sharpening steel | standard cut

9 3/4 inch      12 1/4 inch      Form  
●                      ● ● ●                      ●



**9924**  
Sharpening steel | standard cut

9 3/4 inch      10 1/2 inch      12 1/4 inch      14 1/4 inch      Form  
● ● ● ● ● ○ ●      ●      ● ● ● ● ● ○ ● ●      ● ● ● ● ●      ●



**9950**  
Household steel

7 3/4 inch      Form  
●                      ●



**9980 stp**  
Knife sharpener | stainless steel

**9981**  
Replacement rods



**9980**  
Knife sharpener

**9981**  
Replacement rods

● ● ● ● ● ○



**9927**  
Sharpening steel  
12¼ inch  
●



**9929**  
Sharpening steel  
12¼ inch  
●



**219960**  
Sharpening steel | micro fine cut, oval  
12¼ inch    Form  
● ● ● ● ●    ●

**THE NEW GENERATION OF SHARPENING STEELS MADE IN GERMANY**

- 1 Permanently integrated suspension ring boosts occupational safety.
- 2 Stainless steel tag for practical personalisation and secure tracking.
- 3 Ergonomic 2-component handle offers excellent grip and sits securely in your hand.
- 4 Different handle colours support HACCP systems.
- 5 Finger guard protects against slipping.
- 6 Particularly fine cut for extra-sharp knives.



**219965**  
Sharpening steel | micro fine cut, round  
12¼ inch    Form  
●    ●



**9931**  
Knife sharpener

- 



**9937**  
Ergosteel



**SharpX I**  
Sharpening machine | 230 V



**SharpX II**  
Sharpening machine | 230 V



**9999 104**  
Sharpening wheel | D36, 40°



**9999 105**  
Sharpening wheel | D54, 35°



**9999 106**  
Polishing unit | ceramic, 45°



**9999 107**  
Polishing unit | diamond, D16, 40°





**9999 108**  
Sharpening wheel | D25, 40°



**9999 109**  
Polishing wheel | D54, 35°



**9999**  
Wetbelt sharpening machine "Superschiff" | rotary current 380 V, alternating current 230 V



**9999 p**  
Polishing wheel | 200 x 25 mm



**9999 pp**  
Polishing paste



**9999 s**  
Sharpening belt | 800 x 50 mm, K120

## Knife bags and cases



### 6801 sp l

Cook's master case | magn., light version



### 6801 sp rec

Cook's master case | magn., 13 pcs.

Contents: 6801 sp, 8280-23, 3005-16, 8261 wp-25, 8240-10, 8540 p-6, 8210 p-26, 8249, 8252, 9924-25, 9410 p-15, 9488, 8250 9x7, 9466 sp



**8291 b10 pl**

Knife bag | PrimeLine, 10 pcs.

Contents: 8215-26, 9437-18, 9924-31,  
12316-15, 217365-18, 218265 w-25,  
218269 wwl-18, 218315-10, 218455-26,  
218456-18



**8291 10 l**

Knife bag | empty

**8291 b10 bc**

Knife bag | BestCut, 10 pcs.

Contents: 8210 p-26, 8640-8, 8640 w-10,  
8643-6, 8661 w-25, 8670-25, 8680-23,  
8681-18, 9410 p-15, 9922-25

**8291 10 l**

Knife bag | empty



**8291 b8 bc**

Knife bag | BestCut, 8 pcs.

Contents: 8640-10, 8661 w-25,  
8663-15, 8664-18, 8670-20, 8680-23,  
9410 p-15, 9922-25

**8291 8 l**

Knife bag | empty

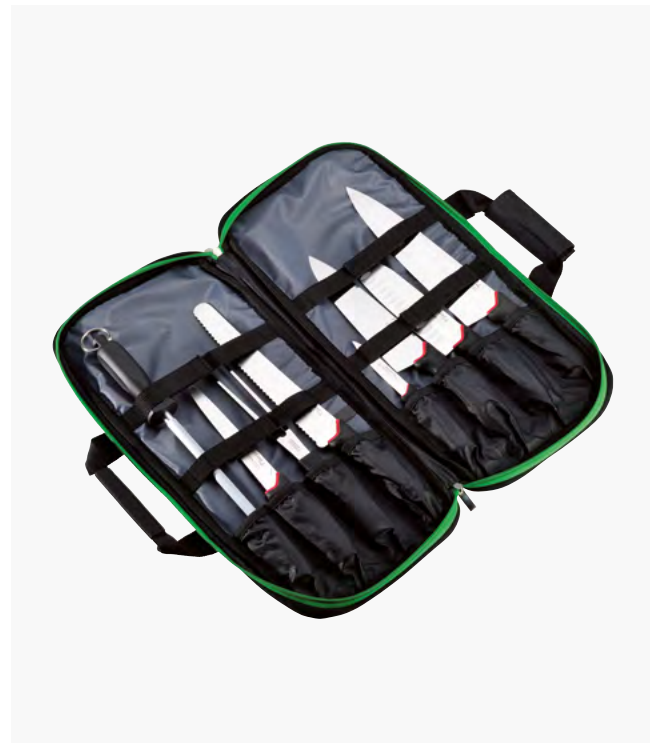

**8291 b8 pl**

Knife bag | PrimeLine, 8 pcs.

Contents: 8269 wwl-18, 9437-18,  
9924-27, 217365-18, 218265 w-25,  
218315-10, 218455-18, 218455-26

**8291 8 l**

Knife bag | empty

**8293 b**

Knife bag | black, 13 pcs.

Contents: 8293 l, 8261 wp-25, 8280-23, 8270-20, 8264-18, 8240-10, 8540 p-6, 9410 p-15, 8255, 8256, 8252, 9488, 8250 9x7, 9924-25

**8293 l**

Knife bag | black,  
black, empty

**8293 bk**

Knife bag | black, 14 pcs.

Contents: 8293 l, 8455-23, 8456-18, 8315 sp-10, 8265 w-25, 7365-16, 9924-25, 9437-18, 8255, 8545 sp-6, 8256, 8252, 8250 9x7, 9488

**8293 l**

Knife bag | black,  
empty

**8296 b**

Knife roll | red, 7 pcs.

Contents: 8280-20, 8270-25, 8264-18, 8240-10, 3100 p-13, 9410 p-18, 9922-25, 8296 l

**8296 l**

Knife roll | red, empty

**8296 bk**

Knife roll | red, 7 pcs.

Contents: 3105-13, 7365-18, 8265 w-25, 8455-20, 9924-25, 8545 sp-6, 8315 sp-10, 8296 l

**8296 l**

Knife roll | red, empty



**8294 b**

Knife roll | blue, 12 pcs.

Contents: 3100 p-13, 8250 sp, 8252, 8210 p-26, 8280-25, 8264-18, 8240-13, 8261 wp-25, 8270-25, 9410 p-18, 7900 p-28, 9920-28, 8294 l

**8294 l**

Knife roll | blue, empty



**8296 5 k**

Knife roll | 5 pcs.

Contents: 8455-20, 7365-18, 3105-13, 8315 sp-10, 9924-25, 8296 5 l

**8296 5 l**

Knife roll | empty



**8298 b**

Knife roll | 7 pcs.

**8298 l**

Knife roll | empty

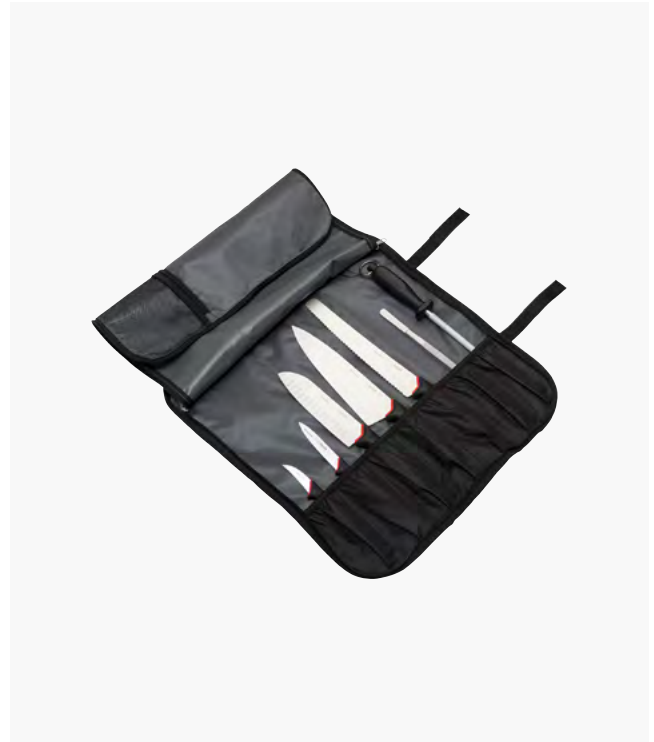

**8298 b pl**

Knife roll | PrimeLine, 7 pcs.

Contents: 218455-23, 218265 w-25, 218269 wwL-18, 218315-10, 218545-6, 9514-30, 9924-25, 8298 l

**8298 l**

Knife roll | empty

**3555**

Knife set | 3 pcs.

Contents: 3105-13, 3005-16, 4025-21

•

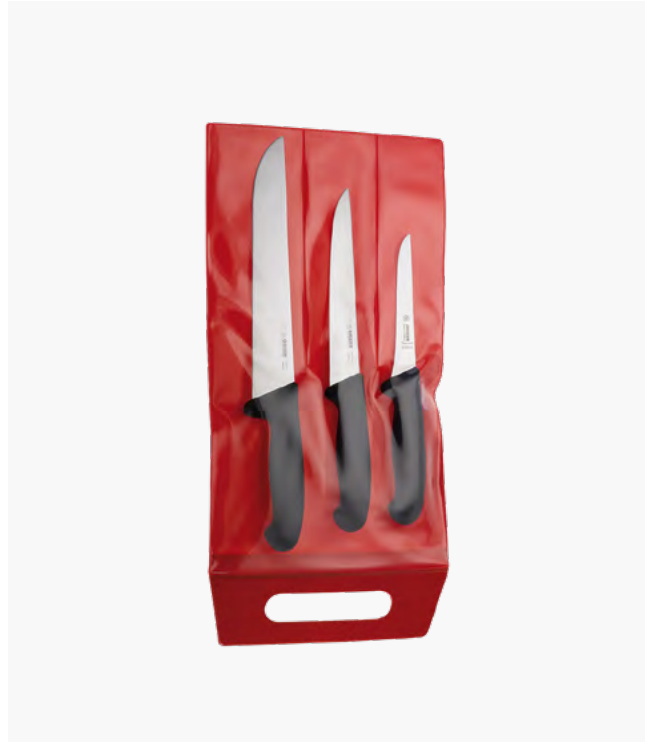
**3565**

Knife set | 3 pcs.

Contents: 3105-13, 3005-18, 4025-24

**3545**

Knife set | 5 pcs.

Contents: 3005-16, 3105-13, 4025-18, 4025-21, 9922-25

•

**3511 pl**

PrimeLine | knife set, 3 pcs.

Contents: 11250-13, 11250-15, 12200-22

•



**9770**

Carving set | 2 pcs.

Contents: 9410 p-15, 8270-18



**9810**

Household set | 4 pcs.

Contents: 8300-8,5, 8360 w-11, 8340-16, 8350 w-18



**9815**

Household set | 4 pcs.

Contents: 8305 sp-8, 8365 wsp-11, 8345-16, 8355 w-18



**9840 bc o**

Knife set | BestCut olive wood, 3 pcs.

Contents: 8640-10 o, 8670-15 o, 8680-20 o



**9840 bc**

Knife Set | BestCut, 3 pcs.

Contents: 8640-10, 8670-15, 8680-20

•



**9840**

Cook's knife set | 3 pcs.

Contents: 8240-10, 8270-15, 8280-20

•

## Knife blocks



### 9891 b5

Knife block | 5 pcs., reasonably priced block in gift box: from beech, assembled with chef's knife 7¾ inch, bread knife 7 inch, kitchen knife 3¼ inch, scissors and sharpening steel



### 9891 b5 bc

Knife block BestCut | 5 pcs., from beech, assembled with chef's knife 7¾ inch, ham slicer 6 inch, office knife 4 inch, scissors and sharpening steel. Packed in attractive cartons





**9891 b5 pl**

Knife block PrimeLine | 5 pcs., from beech, assembled with chef's knife 7¾ inch, santoku knife scalloped edge 7 inch, vegetable knife 3¼ inch, scissors and sharpening steel. Packed in attractive cartons

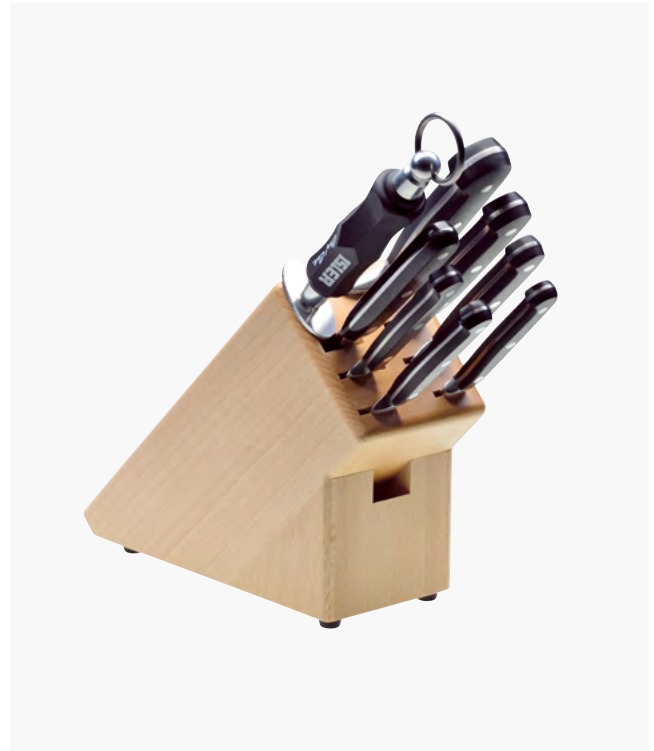

**9892 b**

Knife block | 8 pcs., from beech, assembled with chef's knife 9¾ inch, chef's knife 7¾ inch, chef's knife 6 inch, bird's beak peeling knife 3½ inch, paring knife 4 inch, fork 6 inch, decorating knife and sharpening steel. Packed in attractive



**9892 b9 bc**

Knife block BestCut | 9 pcs., from beech, assembled with chef's knife 7¾ inch, bread knife 7¾ inch, filleting knife 7 inch, fork 6 inch, kitchen knife 6 inch, office knife 4 inch, peeling knife 2¼ inch, scissors and sharpening steel. Packed in attractive cartons



**9891 l 5**

Knife block | empty



**9892 l**

Knife block | empty

# Protective apron

All mesh gloves are available in 7 standard sizes. Left-hander versions and special sizing upon request.



**PERFORMANCE CLASS 2  
DIN EN 13998**

XXS	XS	S	M	L	XL	XXL
SIZE 9	SIZE 0	SIZE 1	SIZE 2	SIZE 3	SIZE 4	SIZE 5
Brown	Green	White	Red	Blue	Orange	Olive
49	50	51	52	53	54	55



**9595**  
Safety apron

Art.-Nr.	Dimension	min.-max.	min.-max.
9595-73	50 x 73 cm	152-173 cm	82-111 cm
9595-78	55 x 78 cm	162-185 cm	89-122 cm
9595-84	55 x 84 cm	175-202 cm	96-133 cm



**9596**  
Bolero

Art.-Nr.	Dimension	min.-max.	min.-max.
9596-85	50 x 85 cm	146-166 cm	82-111 cm
9596-90	50 x 90 cm	156-178 cm	82-111 cm
9596-95	55 x 95 cm	166-190 cm	89-122 cm



**9593**  
Replacement set

9593-00	9593-08	9593-15	9593-19



**9599 s/m/l/xl**  
Cut resistant glove  
extra light and certainly safer protection in 4 sizes (s, m, l, xl), as per EN 388 25 4 x



**9590 m 00**  
Mesh safety glove | fully metal  
● ● ○ ● ●

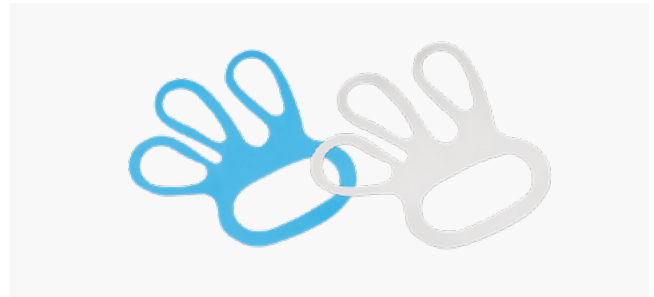

**9594**  
Glove tightener | 100 pcs., one size  
● ○



**9590 mf**  
Mesh safety glove | mitt, one size fits all



**9590 00**  
Mesh safety glove  
● ● ○ ● ●



**9590 08**  
Mesh safety glove  
● ● ○ ● ●



**9590 15**  
Mesh safety glove  
● ● ○ ● ●



**9590 19**  
Mesh safety glove  
● ● ○ ● ●

## Blade protection and knife hygiene



### 9310

Protector | width: 2 inches (2 pcs.)

7 $\frac{1}{4}$  inch      10 $\frac{1}{4}$  inch      12 $\frac{1}{4}$  inch      14 $\frac{1}{4}$  inch



### 9315

Protector | width: 1 $\frac{1}{4}$  inches (2 pcs.)

4 inch      5 inch      6 $\frac{1}{4}$  inch



### MHB I



Knife hygiene box | for 4 knives & 1 steel

50 cm (500 x 265 x 100 mm)

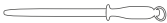

### MHB I E

Insets | for MHB I

Version			
E1	4 x	1 x	-
E2	5 x	1 x	1 x
E3	5 x	2 x	-
E4	8 x	1 x	-



### MHB II



Knife hygiene box | for 6 knives & 2 steels

50 cm (500 x 380 x 100 mm)



### MHB II E

Insets | for MHB II

Version			
E1	6 x	2 x	-
E2	8 x	2 x	-
E5	12 x	2 x	-
E6	10 x	2 x	-



### MHB III

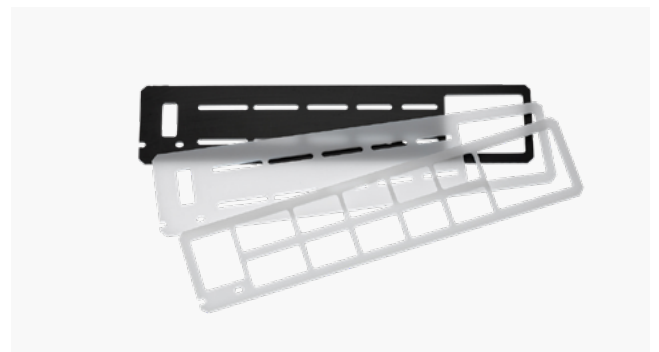

Knife hygiene box | for 5 knives, 1 steel, 1 glove

50 cm (500 x 380 x 100 mm)



### MHB III E

Insets | for MHB III

Version			
E1	5 x	1 x	1 x
E3	10 x	1 x	1 x
E5	8 x	2 x	1 x

**6831 1**

Knife scabbard | for 1 knife, fully hygienic plastic

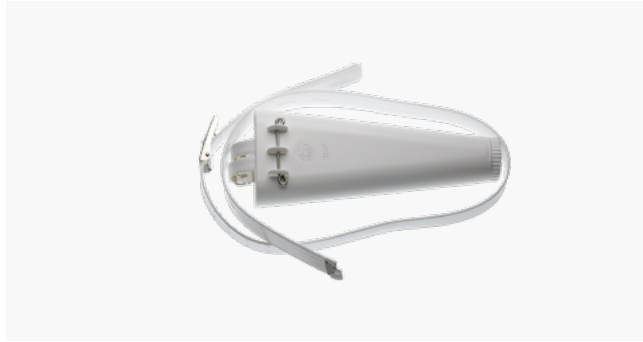
**6830 4**

Knife scabbard | for 4 knives, fully hygienic plastic, complete set

**MHB K**

Knife hygiene box | plastic, for 4 knives (max. 12¼ inch blade), 1 steel, 1 Sharp Easy, 1 glove. Weight: 530 g

Dimensions:

width 17 cm, length closed 49 cm, opened 55 cm, depth 7 cm

**MHB K hh**

Glove-holder | for knife hygiene box







# Service

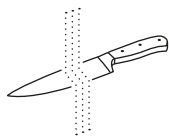

## CLEANING

Look after your knives to protect their outstanding GIESSER quality for many years.

170 – 171



## SHARPENING

Absolute precision: our sharpening recommendations.

172 – 173

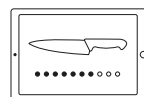

## KNIFE MANAGEMENT

Improve your product safety, work processes and cost controlling.

174 – 175

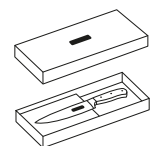

## PERSONALISATION

Give the perfect gift with an individual engraving.

176 – 177

How to make your Giesser knives last as long as possible:  
tips on looking after your knives.

## Cleaning and storage

Our knives with a plastic handle are dishwasher-proof. We nonetheless recommend that you clean them by hand to prevent staining and the build-up of extraneous rust, and to protect the cutting edge of the blade. After cleaning, keep your knives safe with protectors and by storing them in our knife blocks or Gastronorm tray insets. We also offer a wide range of knife bags, cases and boxes to help you transport your Giesser knives safely.



### OUR GUARANTEE

All GIESSER knives with plastic handles are made entirely from materials that comply with the German Food and Commodities Act (LMBG).





## KNIFE CARE

### 1 STORAGE

Store your knives in a dry, secure place. Never leave them lying around near children.

### 2 SAFETY

Giesser knives are very sharp. Be careful when cleaning, drying and handling their blades.

### 3 SHARPENING

Regularly sharpen the blade with the honing steel or a fine whetstone. This maximises the useful life of the cutting edge and keeps it sharp.

### 4 CUTTING BOARDS

Use a cutting board made from wood or plastic. Marble and granite boards damage the blade.

### 5 HANDLES

Our plastic handles are very low-maintenance. Wooden handles benefit from occasional treatments with suitable oils.

Have a look at our website for more information:  
[www.giesser.de](http://www.giesser.de)

Looking after Giesser blades: regularly sharpen and hone the blade to keep it sharp – day after day and for many years to come.

# Sharpening

Professional cooking and butcher knives have to withstand a wide variety of mechanical stress. All working environments are different, and no two cuts are alike. High mechanical pressure and varying foodstuffs have a corresponding impact on the blade. You can prevent wear by sharpening your Giesser knives regularly to protect their sharpness and their cutting-edge retention. All you need is a little practice and the right sharpening tools.

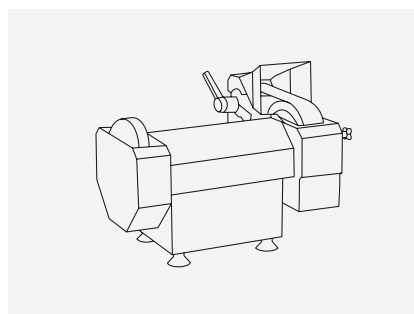

## BECOME A SHARPENING EXPERT

Our sharpening seminars teach you how to sharpen and hone your hand knives using a honing steel, whetstone or a sharpening machine. Find out about the seminars on our website: [www.giesser.de](http://www.giesser.de)

Sharpening machines are additional methods to honing steels and whetstones. Like the manual tools, they protect the sharpness and the cutting edge of your knives. Find out more about our machines on page 152 or in the service section of our homepage.

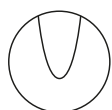

### INCORRECT

An obtuse cutting angle leads to quick blunting of the cutting edge.



### INCORRECT

Blades ground too thin (hollow grind) may chip even at minimal strain.



### INCORRECT

Grinding the blade into a straight wedge shape reduces cutting-edge retention considerably.



### CORRECT

The perfect blade: its slightly convex edge ensures both, sharpness and stability.

## Honing steel

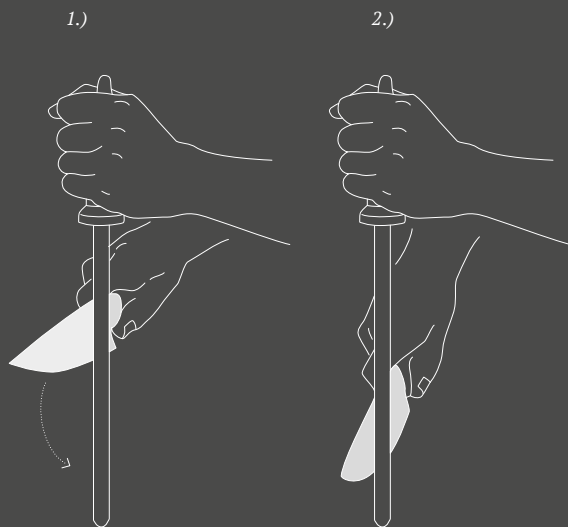

Just a few even strokes on a traditional honing steel will usually restore the sharpness of any blade. But different blades require different stroke techniques. Always slide the knife over the steel in a cutting motion at an angle of 15–20 degrees. Alternate between the left and right side, keep your wrist relaxed and move in a wide arc. The force with which the knife should be pressed against the steel depends on how worn the blade is. Do not use any pressure for a new, unsharpened blade, little pressure for a slightly worn blade and a lot of pressure for a heavily worn blade.

## Whetstone

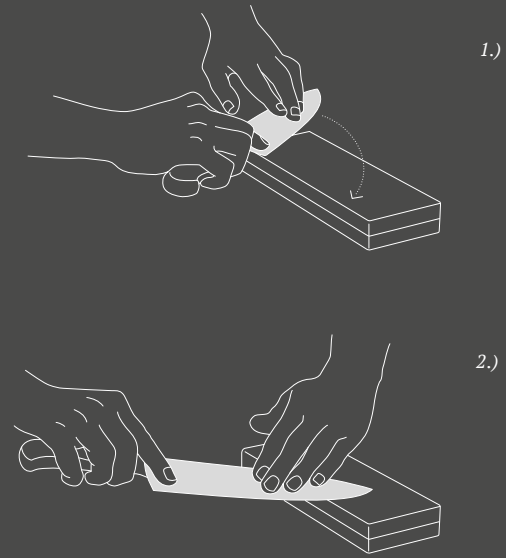

A whetstone allows you to sharpen even the bluntest knives from scratch. It achieves results where a honing steel fails. We recommend using combination whetstones with a fine grit side and an extra-fine grit side. Use an angle of 15–20 degrees, as you would with a honing steel. First, whet both sides of the blade on the rougher side of the stone by guiding them across the stone alternately and evenly. Afterwards, use the finer side to smooth the blade.

Organisation is key! MEMSYS improves your product security, boosts your work processes and helps you control spending.

# Knife management

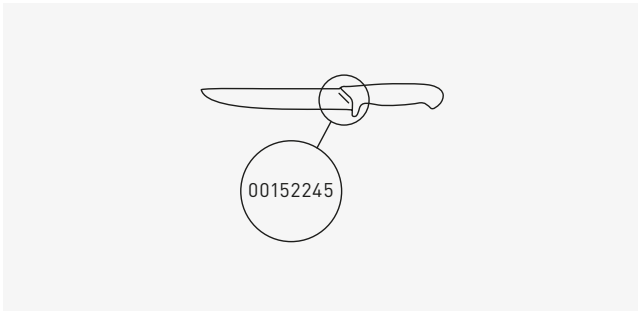

## 1 INDIVIDUAL LABELLING

Your Giesser knives can be labelled with sequential serial numbers upon request. This system gives you complete, transparent insight into their useful life from production to utilisation and disposal. We also offer customised labelling for companies.

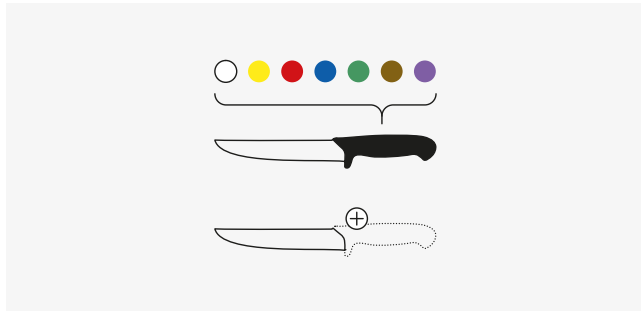

## 2 MEANINGFUL HANDLE COLOURS

Colour-coding your knives is an excellent way to assign them to different processes, departments or shifts. Giesser offers twelve handle colours as a standard. We are happy to provide you with individual or company-specific colours upon request.

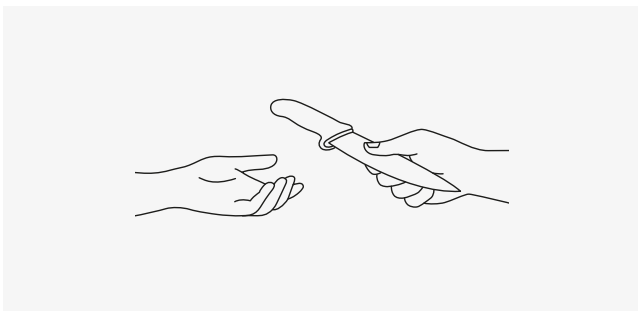

## 3 CONTROL

Each new knife's serial number is entered into the management system and assigned to the employee the knife is issued to. This makes it easy to monitor sharpening and maintenance intervals. New knives are only issued when a used one is returned; the condition of each used knife is verified upon its return.

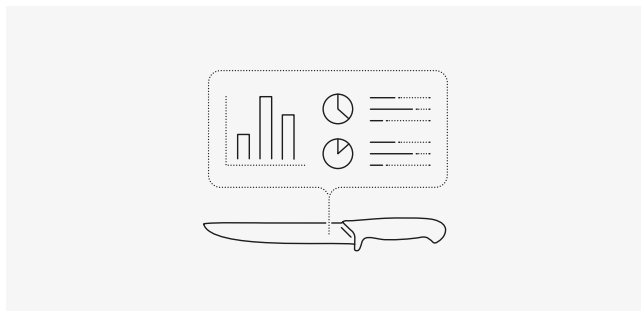

## 4 DOCUMENTATION

To ensure process security, MEMSYS supports seamless, permanent documentation that can be managed easily in Excel. This allows the user to analyse individual wear, current requirements and the exact cost involved. Veterinarians and auditors require such documentation within the scope of IFS certification.



## Tool-Check

The one-stop program to manage, personalise and control tools and equipment.



Find out more: [www.giesser.de/english/News/Downloads/Brochures](http://www.giesser.de/english/News/Downloads/Brochures)

Knife management has become an indispensable part of the food processing industry and its various certifications. Giesser's 'Tool Check' software manages your tools and staff and even offers data analysis. This allows you to identify the user of every single knife. Your employees feel greater responsibility for their knives and handle them more carefully, helping you save expenses. No specialist IT knowledge is required to operate this self-explanatory program. Thanks to its web-based interface, Tool Check stays updated on its own without any complicated steps on your part.

Giesser knives have personality.  
A customised engraving turns them  
into special, unique gifts.

# Your very own knife.

**“Good knives have a long life. We use them every day and they are always in sight. This makes them perfect gifts and brilliant advertising items.”**

A tangible message – literally: use our personalisation service to create knives with a personal message for your family, friends or business partners. We offer laser inscriptions even for single-item orders. You get to choose whether your engraving is placed on the front or back of the knife. For orders of 250 items or more, we can also print your message on the knife handles in one or multiple colours. Of course, we also offer optimal packaging for any knife or knife set: wooden or cardboard boxes, with or without a cover print, you name it.

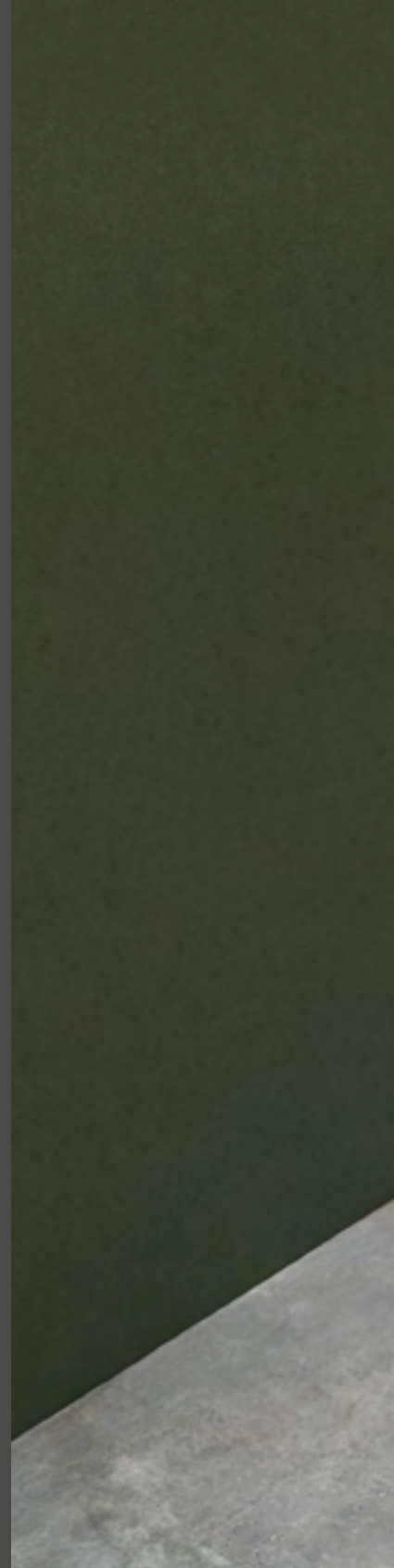





### 1 BLADE INSCRIPTIONS

Subtly stylish: have your own or your customer's company name written on the blade of a quality knife. Please get in touch to discuss the available options.

### 2 EMBOSSED HANDLE

Visuals on the handle of a knife are a special eye-catcher. Upon request, we also offer this service in your personal company colour.

### 3 PACKAGING

Our service also includes individual packaging design. We will be happy to talk about your own ideas and requirements.

# Index

No.	Page	No.	Page	No.	Page	No.	Page
1900	116	3110	80	6820 h	142	8241	76
1910	117	3115	48	6820 la	142	8242	127
1920	117	3145	48	6830	166	8243	76
1930 w	118	3165	48	6831	166	8244	77
1940	118	3167 pp g	67	6840 p	142	8246	131
1950	119/120	3165 pp hvi	100	6845	142	8247	112
1955	121	3168	66	6850	145	8249	131
1960	121	3169	64	6860	145	8249 m	131
1965	122	3185	48	6865	141	8249 mz	132
1988 2	123	3186	48	6867	142	8249 rap	131
1996 3	123	3215	49	6867 kl	142	8249 sp	131
1997 2	124	3215 9,5 e101	49	6868	141	8250 9x7	130
1999 3	125	3235 z	113	6870	141	8251	76
2005	46	3305	49	6880	142	8252	133
2005 det	68	3405	49	7105	51	8253	133
2005 wwl	56	3425	50	7105 w	51	8253 o	133
2007 pp g	67	3426	50	7300 p	83	8253 ow	133
2008	66	3427	50	7305	51	8254	132
2008 wwl	57/66	3511 pl	61/158	7305 aw	52	8255	132
2015	46	3545	158	7305 st	51	8256	132
2025	46	3555	158	7305 w	51/101	8256 lo	132
2105	46/110	3565	158	7305 wwl	57	8256 sp re	132
2105 wwl	56	3585	96	7305 wwl aw	57	8257	132
2275	47/110	4005	50	7365	52/91/110	8258	140
2285	47/110	4005 wwl	57	7700 wp	83	8258 f	140
2400	79	4020	80	7705	52/89	8258 sp	140
2405	47	4020 fsc	80	7705 aw	52	8258 spf	140
2503	63	4025	50	7705 w	52/90/101	8259	132
2504	63	4025 pp hvi	100	7705 wpp hvi	100	8260 w	77
2505	47	4025 wwl	57/111	7705 wwl	57	8260 w o	75
2505 det	68	4028	66	7725	54	8261 w	81
2505 wwl	56	4035	50	7745	52	8261 wp	83
2507 pp g	67	4056-6	54	7755	54	8262 p	83
2509	64	4065	54	7905	52	8263	77
2515	47	5005	51	7905 w	53	8264	77/110
2515 det	68	5065	51	7925	53	8265 w	91/96
2515 wwl	56	6005	51/110	7935	53	8265 w l	91
2517 pp g	67	6005 pp hvi	100	7945	53	8269	77
2519	64	6005 wwl	57	7945 aw	53	8269 k	90
2535	48	6605	143	7965	53	8269 wwlk	90
2535 wwl	56	6606	143	7965 aw	53	8270	77/110
2539	64	6608	144	7965 w	53	8280	78/109
2603	63	6609	144	7981 c	146	8280 w	78/109
2605	47	6610	144	7981 csp	146	8284	78
2605 wwl	56	6611	144	7984 c	146	8287	134
2605 f wwl	56	6612	145	7984 c-h	146	8288	134
2615	47	6615	144	7990	146	8291 b bc	74/155
3000 fsc	79	6615 a	144	7990-3	146	8291 b pl	155
3000 n	79	6616 g	144	8136	101	8291 l	155
3002	65	6630 k	143	8136 w	101	8293 b	156
3000	79	6640 p	143	8137 w	101	8293 bk	156
3005	49	6645	143	8137 wz	101	8293 l	156
3005 det	68	6655	143	8165 z	102	8294 b	157
3005 wwl	56	6655 sp	143	8205	102	8294 l	157
3007 pp g	67	6665	90	8215	102	8296 b	156
3008	66	6688	145	8225	103	8296 bk	156
3055	111	6698	145	8232	102	8296 k	157
3055 f	111	6699	145	8232 f	103	8296 l	156/157
3080	79	6795	144	8232 p	102	8298 b	157
3082	65	6800	140	8233	103	8298 b pl	157
3085	49	6800 h1	140	8234	103	8298 l	157
3100	80	6800 h2	140	8234 p	103	8300	80
3100 fsc	80	6800 sp	140	8235	102	8300 fsc	80
3100 p	82	6801 sp l	154	8237	103	8305 sp	93
3105	48	6801 sp rec	154	8239	103	8305 wsp	93
3105 wwl	57	6810 b	135	8239 s	104	8307 wsp	104
3107 pp g	67	6810 l	135	8240	76	8309 sp 8-5	94

No.	Page	No.	Page	No.	Page	No.	Page			
8309	wsp 8-5	94	8795		92	9593		162	9999 105	152
8310	p	82	8795 w		92	9594		163	9999 106	152
8315	sp	93	9310		164	9595		162	9999 107	152
8315	sp hvi	100	9315		164	9596		162	9999 108	153
8315	wsp	93/111	9400 p		139	9599		162	9999 109	153
8330		81	9410 p		139	9605		106	9999 p	153
8330	fsc	81	9420 p		139	9605 bs		130	9999 pp	153
8330	p	82	9435		92/139	9605 ww		106	9999 s	153
8335		91	9437		92/139	9615		106	11200	59
8335	s	111	9445		139	9615 ww		106	11250	59
8340		80	9450		126	9620		106	11251	59
8340	fsc	80	9450 o		126	9630		107	11253	59
8340	p	82	9450 p		126	9631		107	12200	59
8345		91	9465 sp		95	9645		107	12200 wwl	59
8350	w	81	9466 sp		95	9655		107	12250	59/113
8350	wp	83	9467 sp		95	9655 sp		107	12251	59
8355		104	9468 sp		95	9750		127	12251 wwl	60
8355	w	91/104	9470		131	9750 o		127	12253	60
8355	wsp	104	9471		133	9750 p		127	12260	60
8360	w	80	9475		131	9770		159	12260 wwl	60
8360	w fsc	80	9476		130	9810		159	12300	60
8360	wp	82	9478		135	9815		159	12308	60
8365	sp	92	9478 5		136	9840		159	12310	60
8365	wsp	92	9480 sp		133	9840 bc		159	12316	60
8365	wsp 11-6	95	9482		134	9840 bc o		159	12402	61
8366	wsp	93	9482 w		134	9850		96	12600 wwl	61
8375	w	91/105	9483		137	9851		97	12730	61
8395	w	105	9487		134	9852		97	69505	98
8396		105	9487 sil		134	9872 kt		98	217365	85
8396	w	105	9488		137	9872 spvk		98	217705 w	61/87
8445	stpp	89	9489		137	9872 spvk 9x8		98	217705 w10	86
8450		81	9491		134	9879 sp		97	218265 w	87/104
8450	fsc	81	9492		107	9891 b5		160	218265 w10	86
8450	p	83	9493		107	9891 b5 bc		160	218269 sp	85
8451	p	83	9495		108	9891 b5 pl		161	218269 wwl	85
8455		89/96/109	9495 rs		108	9891 l 5		161	218315	85
8455	pp hvi	100	9500		138	9892 b		161	218335	85
8455	w	91/109	9500 au		138	9892 b9 bc		161	218455	85
8456		89/96	9500 co		138	9892 l		161	218355 w	87
8456	pp hvi	100	9500 cr		138	9901		149	218355 w10	86/104
8475		90	9500 fi		138	9904		149	218365 w	85
8475	wwl	90/111	9500 la		138	9905		149	218456	85
8540	p	82	9500 li		138	9906		149	218545	87
8545	sp	93	9500 ro		138	9913		149	218815	86
8610	p	74	9501		140	9916		149	218825	86
8640		73	9505		113	9919		148	219437	86/139
8640	o	75	9505 k		113	9920		149	219929 ng	87
8640	w	73	9505 sp		113	9922		150	219933 no	87
8643		73	9506		140	9924		150	219960	86/151
8661	w	74	9510		135	9925		150	219965	86/151
8661	w o	75	9514		136	9927		151	228835	87
8664		73	9514 ang		136	9929		151	229605 ww	87
8670		73	9514 k		137	9930		148	MHB I	165
8670	o	75	9515		112	9931		152	MHB I E	165
8670	w	73	9516		112	9937		152	MHB II	165
8680		74	9516 ang		136	9940		148	MHB II E	165
8680	o	75	9518		112	9950		150	MHB III	165
8680	w	73	9535		137	9970		148	MHB III E	165
8681		74	9540		136	9970 99		148	MHB K	166
8710		80	9542		136	9970 s		148	MHB K hh	166
8710	fsc	80	9545		136	9970 wb		148	px 88	149
8725	sp	94/127	9550		112	9970 wt		148	SharpX I	152
8725	wsp	94/127	9551		112	9980		150	SharpX II	152
8730		80/127	9570		137	9980 stp		150		
8750	pz	126	9575		104/137	9981		150		
8750	z	81/126	9590		163	9999		153		
8750	z o	126	9590 mf		113/163	9999 104		152		

# Notes

A series of horizontal dotted lines for writing notes.



JOHANNES GIESSER MESSERFABRIK GMBH

Johannes-Giesser-Straße 1  
DE-71364 Winnenden · Germany

Telefon +49(0)71 95/18 08-0  
Telefax +49(0)71 95/6 44 66  
E-Mail [info@giesser.de](mailto:info@giesser.de)

You can find all products from the  
Johannes Giesser Messerfabrik at  
[www.giesser.de](http://www.giesser.de)

Technical or visual changes, layout and printing errors  
excepted. Colouration of the actual products may deviate  
from printed images for technical reasons.

